

WHEEL LOADER

OPERATION & MAINTENANCE MANUAL

**WARNING**

Operators and service people should read this manual thoroughly before beginning operation or maintenance to avoid serious accident. This manual should be kept properly so that relevant people can read it for reference.

CONTENTS

CHAPTER I INTRODUCTION	4
1. Nameplate	4
2. Intended use	4
3. Features	5
CHAPTER II SAFETY	6
1. General precautions	6
2. Precautions during operation	8
3. Precautions during maintenance	14
4. Safety labels	17
CHAPTER III INTRODUCTION	20
1. General view of gauges and controls	20
2. Explanation of gauges and controls	27
3. Operation	30
4. Transportation	43
5. Cold weather operation	44
6. Long-term storage	46
7. Troubleshooting	47
CHAPTER IV MAINTENANCE	57
1. Guides to maintenance	57
2. Detailed rules of maintenance	59
3. Content of maintenance	66
CHAPTER V STRUCTURE & OPERATION OF KEY COMPONENTS ..	69
1. Engine	69
2. Transmission system	69
3. Working hydraulic system	70
4. Brake system	71
5. Steering system	72
6. Electric system	73

CHAPTE I INTRODUCTION

1 NAMEPLATE

The nameplate is fixed on rear front side of rear frame, indicating the model, serial No, delivery date and manufacturer of the machine.

2 INTENDED USE

The single-bucket, front dump, articulated and tire-type wheel loader is a kind of high efficient, multi-purpose construction machine widely used in mineral yards, construction yards, roads, enterprises, stocking fields and ports.

- Loading operations
- Pushing operations
- Leveling operation
- Digging operation

For the details of the operating procedure, refer to 3.9 "WORK POSSIBLE USING WHEEL LOADER" in ChapterIII.

3 FEATURES

- The optimized linkage system, with large lifting breakout force, high loading efficiency of the bucket and high productivity.

- Longer wheelbase for larger tipping load and higher longitudinal stability.

- The machine is equipped with the newly designed steel cab, with high sealing and damping and better visibility. The highly leveled decoration for improved comfortability, cooling and heating AC.

- The optimized linkage system, with large lifting breakout force, high loading efficiency of the bucket and high productivity.

- The reasonable power match includes the large-displacement working pump for higher productivity.

- The dust-proof design of the pins largely improves the working life.

- The patented hydraulically control has the features of light and reliable operation.

- The articulated frame, with larger turning angle , small turning radius and flexibility.

- The machine adopted the optimized and improved sealing structure, which improves the reliability of the sealing performance in the hydraulic system.

- Five options: log clamper, pipe clamper, longer LA, enlarged bucket, rock bucket, cooling & heating AC.

CHAPTER II SAFETY



WARNING

Read and follow all safety precautions. Failure to do may result in serious injury or death.

1 GENERAL PRECAUTIONS

Warning: For reasons of safety, always follow these safety precautions.

1.1 Safety Rules

- Only trained and authorized personnel can operate and maintain the machines.
- Follow all safety rules, precautions and instructions when operating or performing maintenance on the machine.
- When working with another operator or with a person on worksite duty, be sure that all personnel understand all hand signals that to be used.

1.2 Safety Features

- Be sure all guards and covers are in their proper position, and repair them when damaged.
 - Use safety features such as parking lock lever properly.
 - Never remove any safety features. Always keep them in good operating condition.
- Improper use of safety features could result in serious bodily injury or death.

1.3 Clothing and Personal Protective Items

- Avoid loose clothing, jewelry, and loose long hair. They can catch on controls or in moving parts and cause serious injury or death. Also, avoid wear oily flammable clothes.
- Wear a hard hat, safety goggles, safety shoes, mask or gloves when operating or maintaining the machines. Wear safety goggles, a hard hat and heavy gloves if the job involves scattering metal chips or minutes materials particularly when driving pins with a hammer or cleaning the air cleaner element with compressed air. Be sure that no one is near the machine.

1.4 Unauthorized Modification

- Any modification made without authorization from the manufacturer can create problems with safety.

- Consult the manufacturer before modification, otherwise, the manufacturer will not be responsible for any injury or damage caused by any the unauthorized modification.

1.5 When Leaving Operator's Seat

- Keep the Parking Lock Lever to Lock position.
- Lower the work equipment completely to the ground, level the bucket and operate the Gearshift control lever and Work Equipment Control Lever to Neutral position, stop the engine and lock the electric lock.

Refer to 3.11 "PARKING MACHINE "in Chapter III.

1.6 Mounting and Dismounting

- Never jump on or off the machine. Never get on or off a moving machine.
- When getting on or off the machine, face the machine and hold the handrails and steps.
- Never hold any control levers when getting on or off the machine.
- Maintain three-point contact with the handrails and steps to ensure safety.
- If there is any oil, grease, or mud on handrails and steps, wipe it off immediately to keep these part clean. Repair any damaged parts and tighten the loose bolts.

1.7 Fire Prevention for Oil and Fuel

Fuel, oil and antifreeze are flammable. Fire prevention is necessary especially to fuel.

- Keep flame away from flammable fluid.
- Stop the engine and keep fire away when refueling.
- Refueling and oiling should be made in well-ventilated areas.
- Tighten all fuel and oil tank caps securely.
- Keep oil and fuel in determined places and keep unauthorized persons away.

1.8 Precautions When Handling at High temperature

● Immediately after operations are stopped, the coolant, engine oil, hydraulic oil are at high temperature and under pressure. Attempting to remove the cap, drain the oil or water or replace filters may lead to serious burns. Always wait for the temperature to go down, and follow the specified procedures when carrying out these operations.

- Stop the engine, wait for the water to cool then loosen the cap slowly to relieve the pressure before removing the cap of radiator.

1.9 Crushing or Cutting Prevention

- Do not enter, or put your hand or arm or other body parts between movable parts as work equipment and cylinders or between machine and work equipment. If the work equipment is operated, the clearance will change and may lead to serious damage or personal injury.

2 PRECAUTIONS DURING OPERATION

2.1 Before Starting Engine

2.1.1 Safety at Worksites

- Before starting operation, check the area for abnormal conditions that may lead danger.
- Examine the terrain and soil quality at the jobsite, and determine the optimum method of operation.

- When working on public roads, position flagmen and erect barriers to ensure safe passing traffic and pedestrians.

- In places when there are buried pipes of water, gas or high voltage cables, contact the responsible companies to confirm the position of the objects and take care not to damage them during operation.

- When working in water or passing sand banks, check the ground condition, speed and depth of the water. Be sure not to exceed the permitted depth of water.

For permissible water depth, refer to 3.10 "Precautions for Operation" in Chapter III.

2.1.2 Fire Prevention

- Remove flammable materials as wood chips, leaves, paper, etc accumulated on engine and brake pliers to avoid fire.

- Check fuel, lubrication and hydraulic systems for leaks, repair the leaking points and wipe the surfaces clean.

Refer to 3.1 "CHECKS BEFORE STARTING" in Chapter III.

- Be sure a fire extinguisher is present.
- Never operate the machine near any fire or flame.
- Avoid short-circuit starting.

2.1.3 In Operator's Cab

- Never leave tools or spare parts lying around in the cab, which should be kept in the tool box, to avoid accidents.

- Keep cab floor, controls, steps and handrails free of oils, grease, snow or other dirt.

2.1.4 Ventilation

- If the machine must be started in the closed room, enough ventilation is necessary to prevent damage or personal injury caused by exceeding exhaust gas.

2.1.5 Mirror, Glass and Lamps

- Keep the window glass and lights clean to ensure good visibility.
- Adjust the back-view mirror and keep the surface clean to ensure best view from operator's seat. Replace with a new part if the mirror is damaged.
- Be sure that all lamps are in good working condition.

2.2 Operation

2.2.1 Before Start the Engine

- Walk around the machine again before mounting it, ensure no person or barrier around.
- Never start the engine if a warning tag has been attached on the control lever.
- Start the engine only after seated.
- Unauthorized personal is not allowed to enter into cab or other place of the machine.
- Sound the horn as an alert to personal around.

2.2.2 Check When Reversing

Always do the following before operating the machine.

- Sound the horn to warn the personal in the area
- Be sure that nobody is near the machine, pay particular attention to the place behind.
- Designate a person to check for safety when necessary.
- Ensure no unauthorized person can come into the traveling area.
- Designate a person to direct worksite traffic when operating in dangerous sites or when the visibility is poor.

2.2.3 Safety Check

Check whether the Safety Bar of frames is locked securely in Free Position.

2.2.4 Precautions when traveling

- Set the work equipment 40~50mm from ground level when traveling on level ground.
- When traveling on rough ground, travel at low speed and avoid sudden steering.
- If the engine stops suddenly, apply brake immediately and stop the machine.

2.2.5 Traveling on slopes

- Traveling on slope, steep hill-sides or dykes may result in tipping or slipping.
- When traveling on slopes, hill-sides or dykes, keep the bucket approximately 20~30mm above the ground. In case of emergency, quickly lower the bucket down to help stop the machine and prevent from tipping over.
- Never turn on slopes or travel across the slope. Always travel to flat places to perform these operations
- Do not travel on grass, fallen leaves or wet steel plate to avoid slip. Keep at low speed when traveling on the edge of the slopes.
- When traveling downhill, keep at low speed and avoid stopping the engine.
- If the engine stops when traveling on slopes, depress the brake pedal immediately, low the bucket down, put the Gearshift control lever to Neutral position and apply parking brake.
- When traveling on a slope with loaded bucket, drives forward when travel uphill, and reverse when downhill.

2.2.6 Keep Away From High-Voltage Cables

- Do not let the machine touch the overhead electric cables. Maintain the safe distance given below between the machine and cables.
- To prevent accidents, always do as follows:
Wear rubber shoes or lay rubber sheet on operator's seat.
Use a signal- man to direct traffic when approaches too close to electric cables.
- If the work equipment touch the electric cable, the operator should not leave the cab.
- When operate the machine near the high-voltage cables, prevent other persons from keeping near to the machine.
- Contact with the electric company to check the voltage of cables before operation.

Voltage	Min. Safety Distance
6.6kV	3m
33.0kV	4m
66.0kV	5m
154.0kV	8m
275.0kV	10m

2.2.7 Precautions When Operation

- Be careful not to approach too close to the edge of the cliff. When making the embankments or land hill, dump one pile then use the next pile to push the first one.

- Do not let the bucket hit the dump truck or canal side.
- The load suddenly becomes lighter when the soil is pushed over a cliff or when the machine reaches the top of a slope, there is danger that the travel speed will suddenly increase, be sure to reduce the speed.
- When the bucket is fully loaded, never start, turn or stop the machine suddenly.
- When loading dump trucks, ensure nobody is in the jobsite, and decrease the impact force when dumping.

2.2.8 Ensure Good Visibility

- When working in dark places, turn on working lamps and head lamps, and set up lightening in work area if necessary.
- Stop operation if the visibility is poor, such as in fog, snow and rain and carry out operation when the weather condition is improved.

2.2.9 Operate Carefully On Snow

- When working on snow or icy roads, even a slight slope may cause the machine to slip to the side, so always travel at low speed and avoid sudden starting, stopping or turning.
- When operate the machine to remove accumulated snow, special care should be taken to the road edges or objects buries by the snow.
- When traveling on snow covered roads, always fit the chains.
- When traveling on snow covered slops, lower the bucket down before braking. Never apply brake suddenly.
- When carry out loading operation, never load excessively to avoid slipping.

2.2.10 Do Not Hit Work Equipment

- When working in places where there are height limits, such as in tunnels, under bridges, under electric cables, or in garages, be extremely careful not to hit the work equipment.

2.2.11 Method of Using Brakes

- Do not put your foot on the brake pedal unless necessary.
- Do not depress the brake pedal repeatedly unless necessary.
- When traveling downhill, do not stop the engine, and keep foot on brake pedal.

2.2.12 Working On Loose Ground

- Avoid operating the machine too close to the edge of cliffs, overhangs, and deep

ditches. If these area collapse, the machine could fall or tip over resulting in serious injury or death. Soil is weakened in these areas after heavy wind and rain.

- Soil near ditches is loose and can collapse under the mass and vibration of the machine.

2.2.13 Parking The Machine

- Park the machine on level ground. If it's necessary to park the machine on a slope, block the wheels to prevent the machine from moving.

- When parking on public roads, provide fences, signs, flags or lights and other necessary signals to ensure that the passing traffic can see the machine clearly, and make the machine, flags, fences, etc do not obstruct traffic.

Refers to 3.11 "PARKING MACHINE" in Chapter III.

- When leaving the machine, lower the work equipment completely on the ground, level the bucket, pull the parking brake lever up. Stop the engine and turn the key to Off position.

2.3 Transportation

2.3.1 Loading And Unloading

Loading and unloading the machine involves potential hazards. Extreme caution should be used.

- When loading or unloading the machine, travel at low speed.
- Always block the wheels of hauling machine and both ramps.
- Load and unload the machine on firm, level ground and maintain a safe distance from the edge of the road.
- Be sure the ramps are of adequate strength, width and length.
- Be sure that the ramps are securely positioned and fastened, and that two sides are at the same level.
- Be sure that the surfaces of ramps are clean, without oil, ice or other loose materials. Remove the dirt on wheels of the loader.
- Never correct the steering on the ramps. Drive away from ramps and climb again when necessary.

- After loading, block the machine tires and stop the machine securely.

Loading, unloading and tie-down, see 4 "Transportation" in Chapter III.

2.3.2 Shipping

- When shipping the machine on a trailer, obey local laws governing weight, width and length of a load. Also obey all applicable traffic regulations.

- Take in account the width, length, and weight of the load when determining the shipping route.

2.4 Battery

2.4.1 Battery Hazard Prevention

- Battery electrolyte contains sulphuric acid. Wash with water when splashed on body.
- Battery acid could cause blindness if splashed into eyes, flush them with plenty of water and see a doctor at once.
- If drink electrolyte accidentally, drink plenty of water or milk, beaten eggs or vegetable oils, and call a doctor immediately.
- Wear safety glasses when handling batteries.
- Hydrogen gas generated by batteries can cause explosion when ignited by slight spark.
- Stop the engine and turn the starting switch to OFF position when handling batteries.
- Check the positive and negative terminals when removing or installing the batteries.
- Tighten the battery caps securely.
- Tighten the terminals securely to prevent spark or explosion cause by loosen terminals.

2.4.2 Starting With Booster Cables

- Do not start with booster cable at normal conditions.
 - Wear safety glasses when start the machine with booster cables.
 - When start a machine with batteries on other machine, prevent two machines from contacting with each other.
 - Be sure to connect the positive cable first when installing the booster cables, while disconnected the negative first when removing.
 - There will be sparks if the tools contacts the frame and the positive terminal at the same time, and careful operation is needed.
 - Connect the batteries in parallel, i.e. positive-to-positive and negative-to-negative.
 - Ground connection to frame of the machine to be started should be fixed securely.
- Starting procedure when using booster cables, see 7.3 "IF BATTERY IS DISCHARGED" in Chapter III.

2.5 Towing

Tie the towing rope on towing pin.

- Injury or death could result if a disabled machine is towed incorrectly.
- If a problem machine is towed by another machine, always use a wire rope with a sufficient towing capacity for the weight of the problem machine.

- Do not tow a machine on a slope.
- Do not use a wire rope that is crinkled or twisted.
- Do not stand astride or near the towing cable.
- When connecting a machine that is to be towed, do not let any one come between the towing machine and the machine that is being towed.
- Set the coupling of the machine being towed in a straight line with the towing portion of the machine, and ensure it in correct position.

See 7.3 "TOWING THE MACHINE" in Chapter III for towing methods.

3 PRECAUTIONS DURING MAINTENANCE

3.1 Before Carrying Out Maintenance

- Always attach the Warning Tag to a control lever in the operator's cab to alert others that you are working on the machine. Attach additional warning tags around the machine, if necessary.

- Use only tools suited to the task. Avoid using damaged, low quality, faulty, or makeshift tools.

Refers to 2.5 "MAINTENANCE TOOLS" in Chapter IV.

- Check and replace critical parts, such as fuel hose, tube and pump oil tubes periodically.

- Before inspection and maintenance, park the machine on level ground and stop the engine. If it's necessary to maintain the machine with engine running, e.g. when clean the inner parts of radiator, put the Parking Brake Control Lever to Lock position and carry out the maintenance operation by cooperation of two persons.

- Lock the frames with Safety Bar.
- When carrying out inspection and maintenance with the work equipment raised, fit stand securely under the lift arm to prevent the work equipment from coming down. Place work equipment control lever at Hold position.

3.2 During Maintenance

- Only authorized personnel can service and repair the machine. Extra precaution should be used when grinding, welding and using a sledgehammer.

- Place attachments that have been removed from the machine in a safe place, so that they do not fall and cause injury to personal.

- Lower all work equipment to ground before performing maintenance or repairing

work under the machine. Always block the tires securely. Never work under the machine if the machine is poorly supported.

- Keep the machine clean, avoid injury caused by spilled oil, grease or falling tools. Never clean the sensors, plugs or inner part of cab with water or steam.

- Always add oil and fuel in well-ventilated areas, and tighten the filler caps securely. Wipe up any spilled fuel and oil immediately. Never clean parts with fuel.

- When checking the coolant level, stop the engine and wait for cooling of engine and radiator. Loosen the cap slowly to release the pressure inside, and then check the coolant level.

- Use explosion-proof light when checking fuel, oil, coolant and battery electrolyte, to avoid explosion.

- When repairing the electrical system or when carrying out welding, remove the negative terminal of battery to stop the electric current.

- Never bend high-pressure hoses or hit them with hard objects. Do not use any bent or cracked piping, tubes or hoses they may burst during use. Repair the loosen or cracked oil lines to prevent fire caused by oil leakage.

- Do not add oil, drain oil or carry out maintenance or inspection before completely releasing the internal pressure. Always wear safety glasses and thick gloves and use a piece of cardboard or wood to check for oil leakage. Consult a doctor immediately if hit by a jet of high-pressure oil.

- Immediately after stopping operations, engine coolant and oil at all parts is at high temperature and under high pressure. In this condition, if the cap is removed, or the oil or water is drained, or filters are replaced, it may result in burns or other injury. Wait for cooling down and carry out the inspection and maintenance.

- Never touch rotating parts as fan blades or belts to avoid injury.

- When carrying out operations with the work equipment or chassis raised, lock the front and rear frames with the safety bar, return the control levers to Hold position. Block the wheels on the opposite side before jacking up. Set blocks under the machine after jacking up.

- Disassembly, repair, and assembly of tires requires specialist equipment and skill, so ask the specialist tire repair shop to carry out repairs.

- Never dump waste oil in a sewer system, rivers. Always put drained oil from machine in containers. Never drain oil directly on the ground. Obey appropriate laws and regulations when disposing of harmful objects such as oil, fuel, coolant, solvent, filters, batteries and others.

3.3 Tires

If the tire is not used in required circumstance or condition, the tire may burst because of over heat or cutting.

To maintain safety, always observe the following:

- Inflate the tires to specified pressure. Insufficient pressure will cause overheat. Proper inflation pressure:

Front tires: 0.333~0.353Mpa

Rear tires: 0.275~0.294Mpa

- Avoid overload

- Only use specified tires

Inflation pressure specified in the manual is normal value. The inflation pressure will be different according to various sizes of tires and working conditions. Please consult the loader manufacturer.

Following operation is forbidden during installation of tires:

- Weld rims

- Make fire or weld near tires or rims.

4 SAFETY LABELS

Always keep the labels clean. If they are lost or damaged, attach them again or replace with new ones. Understand and follow the label information during operation and maintenance.

4.1 Position For Attaching Safety Labels

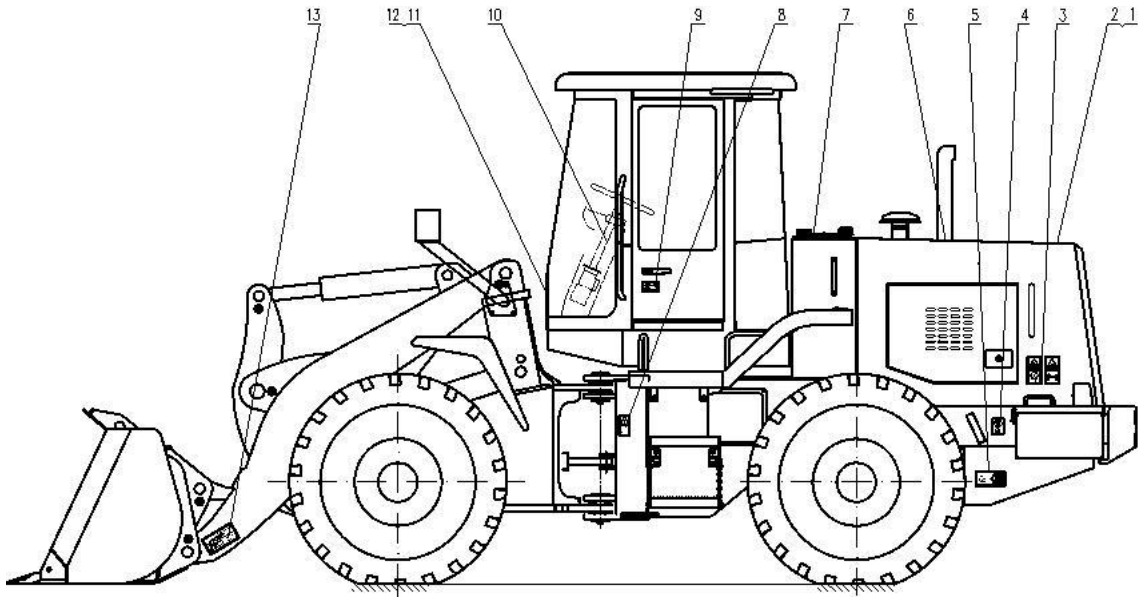

4.2 Label Information

1

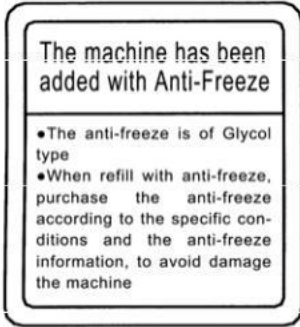

2



5

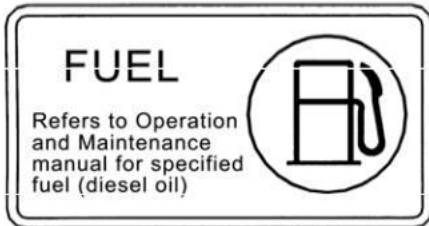

6

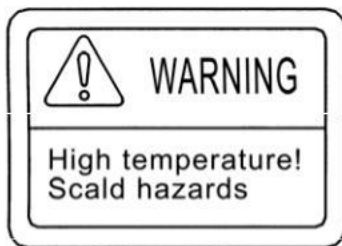

7

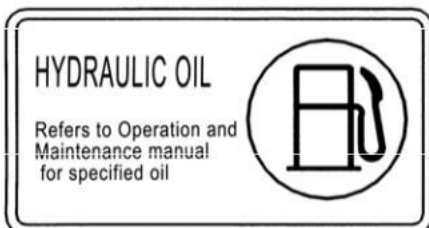

3

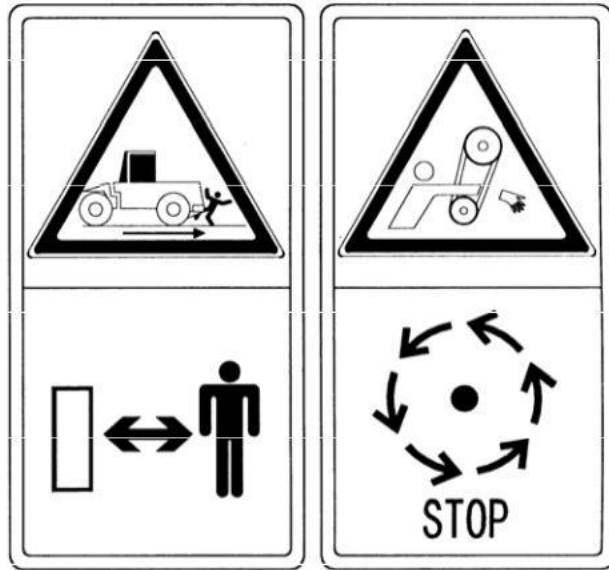

4

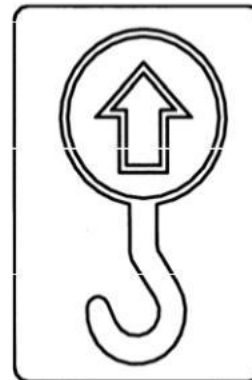

8

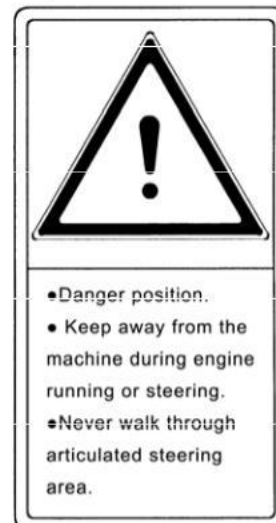

9

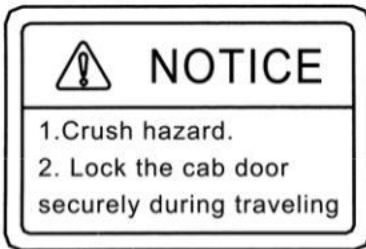

10

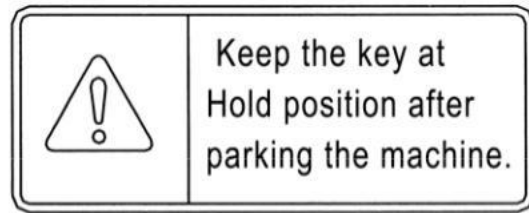

11

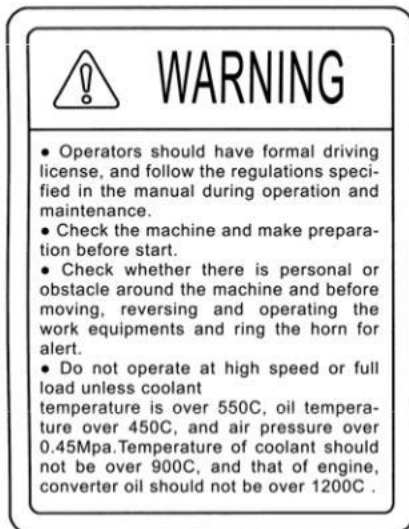

12



13

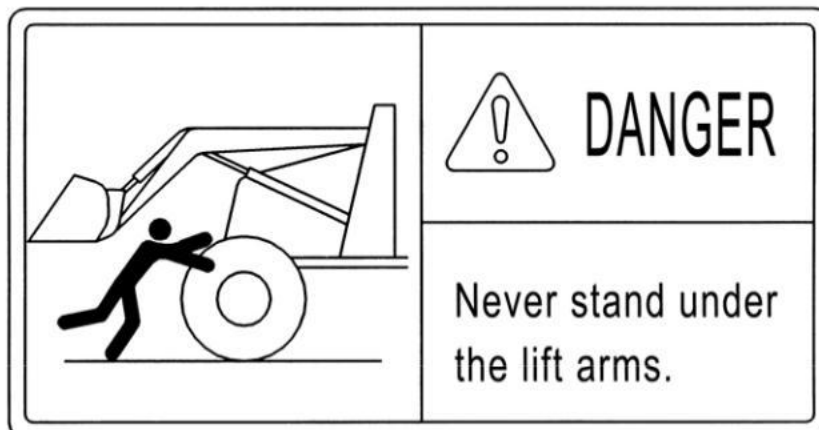

CHAPTER II SAFETY

1 General view of gauges and controls

1.2.2 Steering Wheel

Steering wheel is connected with steering device .When machine runs normally ,turn steering wheel clockwise, then machine turn left ; turn steering wheel anticlockwise , machine turn right .

Features :

- The steering wheel turning angle is not equal to the wheel loader turning angle .Continuously turning the steering wheel to get bigger machine turning angle ,stop until get the required steering position .
- The faster steering wheel turns , the faster machine turns
- The steering wheel wont be self-return after turning , machine would keep the turned angle ,then turn steering wheel reversely to make loader run straight-line .

1.2.3 Control Levers

- **Gear Control Lever**

Refer to “General View of Controls and Gauges Charter 3-1” in this Chapter 1.1

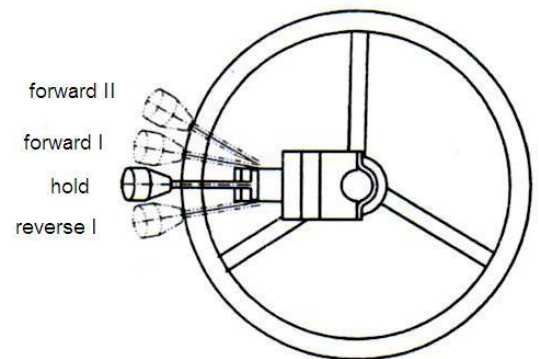

This lever controls the travel speed and direction of the machine .

This machine has 3 gear shifts , 2 forward, 1reverse , that's Forward I ,forward II, Hold, and 1 reverse .

- **Working Equipment Control Lever**



◆ **Bucket Control Lever**

Refer to “General View of Controls and Gauges Charter 3-1”
in this Chapter 1.1

This lever controls bucket and has 3 gears .

- ✧ Tilt: Tilt the bucket back
- ✧ Hold: Keep the bucket at certain position
- ✧ Dump : Dump material from bucket .

◆ **Lift Arm Control Lever**

Refer to “General View of Controls and Gauges Charter 3-1”
in this Chapter 1.1

This lever controls Boom and has 3 gears .

- ✧ Raise: Lift arm up
- ✧ Hold: Keep the lift arm at certain position
- ✧ Lower : Boom down



● **Parking Brake Lever**

The lever is at the left side of the seat ,pull it up to park the machine ; press the top button and push it down to release the parking .

● **Brake Pedal**

Brake pedal controls wheel brake .

Refer to “General View of Controls and Gauges Charter 3-1”in this Chapter 1.1

● **Accelerator Pedal**

Accelerator pedal control the engine speed and output .Refer to “General View of Controls and Gauges Charter 3-1”in this Chapter 1.1

Engine speed can be freely controlled between low idling and full speed .

- **Flameout Control Lever**

At the back of the cab and on the right side of the seat .Pull it and hold on for seconds , engine turn off .

1.2.4 Cab Door Lock Lever and Lock Pin

- Indoor Lock Lever : When cab door lock is in lock-out state ,it would lock automatically after closing the door ; Outside of the cab, insert the key , turning in clockwise direction of 180° ,then take out the key , press and hold the door lock to pull to open ; From the inside , pull upward the lever, door opened .
- Outdoor Lock Lever: Open the door to 180°,then door lock catch hits the positioning lock outside of the cab , door locked ; Pull inward the outdoor lock lever , door unlocked .

1.2.5 Towing Pin

Insert towing pin (1) into counterweight (2)during towing

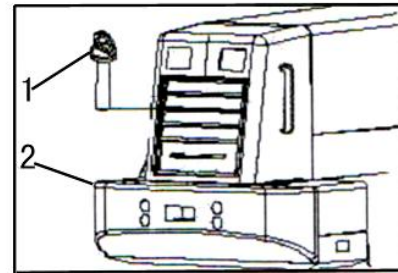

1.2.6 Fuse



WARNING

- Be sure to turn off the starting switch before replacing a fuse .The fuses protect the electrical equipment and wiring from burning out .If the fuse become corroded ,or white powder can be seen , or the fuse is loose in the fuse holder , replace the fuse .
- Replace a fuse with another of the same capacity

1.2.7 Seat Adjustment



 WARNING
<ul style="list-style-type: none">● Park the machine in a safe place and stop the engine when adjusting the operator's seat .● Adjust the seat before starting operation or when changing operators .● Check that you can depress the brake pedal full with your back against the seat backrest .

- Adjust the seat back and forth
Front-back adjustment lever is at the right side of the seat , pull it up to move front and back to the proper position , then lay down the lever to lock the seat .

- Adjust the height
Height adjustment lever located at left-rear corner of the seat , rotate the lever to get the seat in expected position , then lay down lever to lock .

- Backrest Adjustment
Backrest adjustment lever locates at the right-rear corner of the seat , rotate the lever to get backrest to the proper position , lay down lever to lock .



1.2.8 Rear View Mirror

Two rear view mirrors locate outside of the cab , one left, another right ,.Before operating the machine , ensure to adjust the mirror's angle of elevation to keep the driver have a good back view .

INTRODUCTION

Directions indicated in this section are those shown by the arrows in the diagram below.

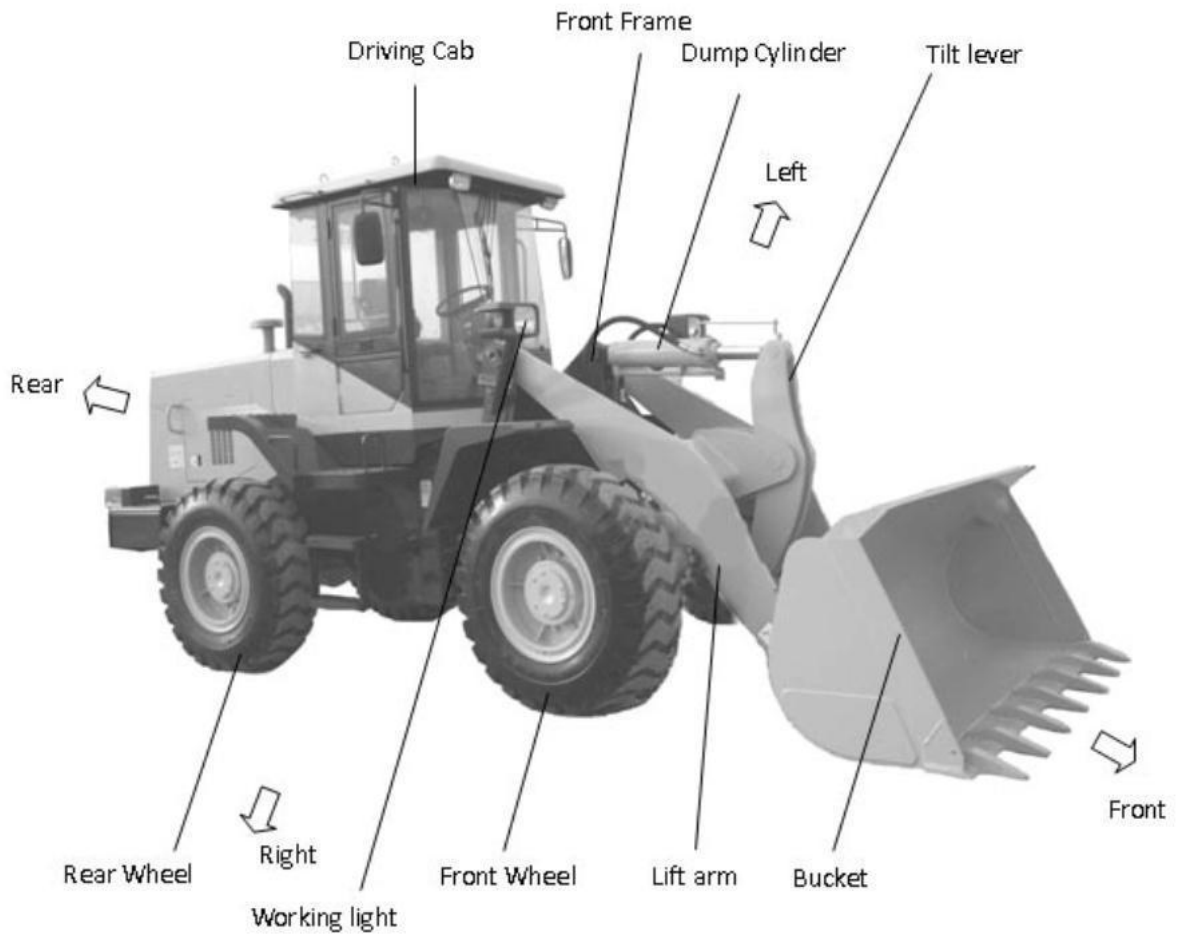

WHELL LOADER

GENERAL VIEW OF CONTROLS AND GAUGES :

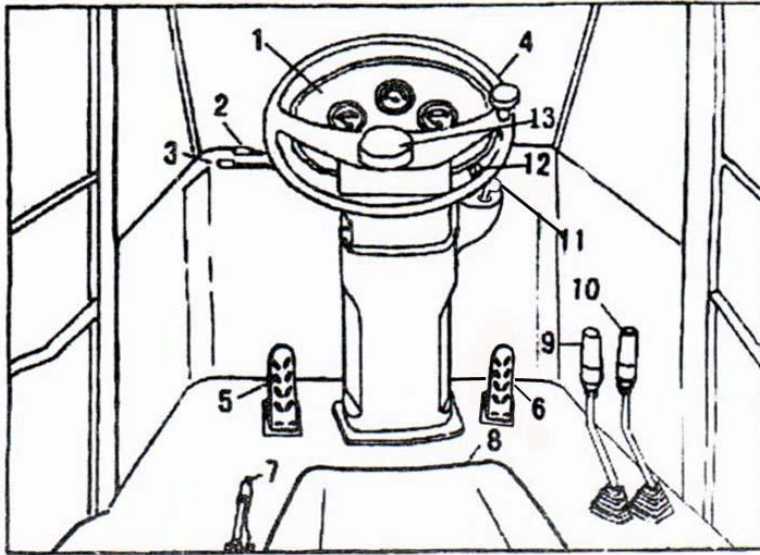

1.Instrument Panel 2.Speed Control Lever 3.Gearshift Lever 4. Steering Wheel 5.Brake Pedal 6. Accelerator pedal 7. Parking Brake Control Lever 8.Seat 9. Bucket Control Lever 10. Lift Arm Control Lever 11. Electric Lock 12. Starting Button 13.Horn

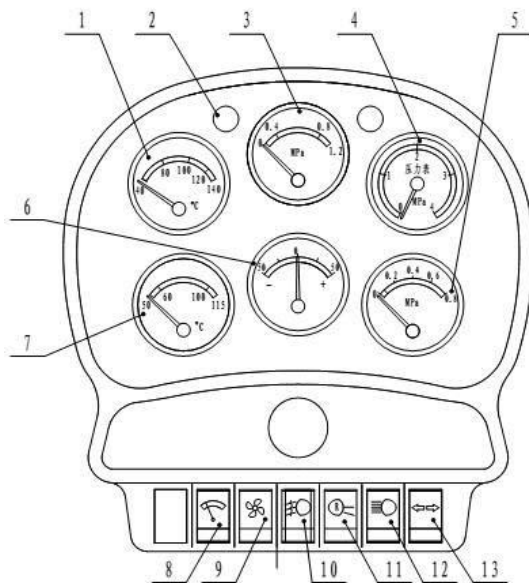

1.Engine Coolant Temperature Gauge 2.Transmission Oil Temperature Gauge 3.Ampere Meter 4.Transmission Oil Pressure Gauge 5. Steering Indicator Light 6.Engine Oil Pressure Gauge 7. Steering Indicator Light Switch 8.Headlight Switch 9.Back Light Switch 10. Fog-proof Light 11. Fan Switch 12.Rain Wiper Switch

EXPLANATION OF GAUGES & CONTROL LEVERS:

2.2.1 Gauges and Lamps

- **Engine Coolant Temperature Gauge**

This gauge indicates the temperature of engine coolant .

Temperature is normal while gauge needle in the green range (60°C ~ 100°C) .

Note :

Do stop to check if the red range lights

Refer to “3.4.2 Stop Engine” in this Chapter to stop machine. The same below .

- **Torque Converter Oil Temperature Gauge**

This gauge indicates hydraulic driving oil temperature .

Temperature is normal while gauge needle in the green range (40°C ~ 120°C) .

Do stop to check if the red range lights

- **Braking Air Gauge**

This gauge indicates the braking system air pressure .

Air pressure is normal while the needle in the green range (0.4~0.8 MPa) ;

Do stop machine to check while needle in other range .

- **Torque Converter Oil Pressure Gauge**

This gauge indicates hydraulic oil pressure of the transmission system.

Oil pressure is normal while the needle in the green range (1.1~1.5MPa) .

Do stop machine to check while needle in other range .

- **Engine Oil Pressure Gauge**

This gauge indicates the pressure of engine oil .

Oil pressure is normal while the needle in the green range (0.1~0.8MPa)

Do stop machine to check while needle in other range .

- **Ampere Meter**

This gauge indicates the electric system current .

Current is normal while the needle in the green range (0~±50A) .

Do stop machine to check while needle in other range .

- **Direction indicator lamp**

Turn on steering switch , direction indicator light flashes .Turn left , left light on ; turn right , right light on .

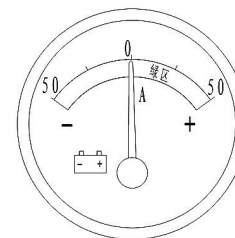
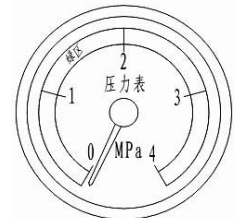
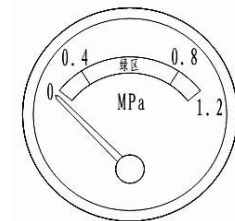
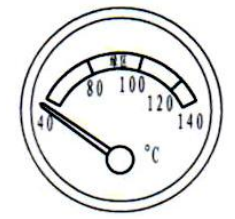

●Pilot Lights

Steering pilot light: to indicate the turning direction.

Charging pilot light: The light is on when the start switch is on. The light is off when the engine is running and charging. If the light is on during the engine running, check the charging circuit.

Low air pressure alarming light: When the brake air pressure is lower than 0.4 Mpa, the light is on.

Parking brake pilot light: When the air pressure is not enough, or when the pressure has reached the green range and the red mushroom head button is pressed down, the light is on. When the pressure is at the green range, and the red button is released, the light is off.

Terminal Position	B	BR	R1	R2	C	ACC
OFF	○					
HEAT	○	○	○			○
ON	○	○				○
START	○	○		○	○	○

2.2 Switches

● Start Switch

This switch is used to start or stop the electric system of the machine and start the engine.

HEAT position

This position is reserved for pre-heating start system, which is not equipped on the basic models and is an optional system for customers.

OFF Position

Insert or remove the key at this position. Turn the key to this position to turn electric circuit off.

ON Position

Turn the electric circuit on. Keep the key at this position when the engine running.

START Position

This is the engine-start position. Keep the key at this position during cranking.

Immediately after engine starting, release the key, which will return to ON automatically. When the Start button is installed on the machine, the START position is useless, and the electric lock is only used to control the electric power to be on or off.

- Brake pedal

 WARNING
<ul style="list-style-type: none">● When traveling downhill, never stop the engine, and use brake pedal.● Do not depress the pedal repeatedly unless necessary.

The brake pedal operates the wheel brakes.

- Accelerator pedal

This pedal controls the engine speed and output.

The engine speed can be freely controlled between low idling and full speed.

- Parking brake switch

This switch is used to control the parking brake. Press the red knob, then the parking brake is in brake. Compress the knob lightly and when it bounces out, the brake releases.

2.4 Safety Bar

 WARNING
<ul style="list-style-type: none">● Lock the front and rear frames with safety bar during maintenance and transporting.● Release the safety bar during traveling.

The safety bar is used to lock the front and rear frames during maintenance and transporting the machine, in order to prevent frames from bending.

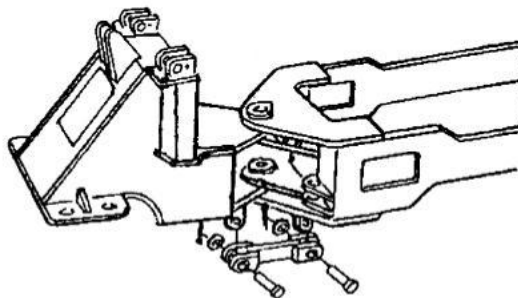

2.5 Towing Pin

Insert the towing pin (1) into counterweight (2) during towing.

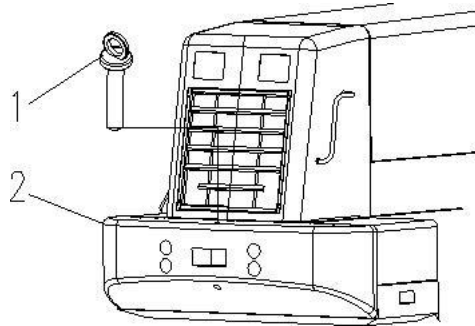

2.6 Fuse

Notice:

Be sure to turn off the starting switch before replacing a fuse. The fuses protect the electrical equipment and wiring from burning out. If the fuse becomes corroded, or white powder can be seen, or the fuse is loose in the fuse holder, replace the fuse.

Replace a fuse with another of the same capacity. The fuse boxes are separately located at the right and left side under the panel.

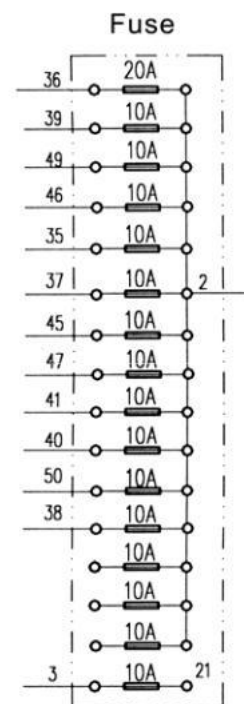

3 OPERATION

3.1 Check Before Starting Engine

3.1.1 Walk -Around Check

WARNING

Leakage of oil or fuel, or accumulation of flammable material around engine muffler, exhaust pipe, brake pliers may cause fire.

Before starting the engine, check for loose connection, or leakage of fuel, oil or coolant and check the condition of work equipment and hydraulic system.

Check also for loose wiring, oil spillage, and collection of dust at high temperature places. Always carry out following items before starting the engine each day.

- Check for cracks, excessive wear, play in work equipment, cylinders, linkages and hoses. If any abnormality is found, repair it.
- Check if there is any dirt accumulated around the engine, radiator or brake pipes, and remove dirt in time.
- Check that there is no leakage of oil from engine or water leakage from cooling system. If any abnormality is found, repair it.
- Check for leakage of oil from transmission case, axle, hydraulic hoses, pipes and joints. If any abnormality is found, repair it.
- Check for oil leakage from brake line. If any abnormality is found, repair it.
- Check for damage or wear to tires, loose mounting nuts or bolts, especially the rim nuts. If any abnormality is found, repair or replace the parts.
- Check for damage to handrails and steps and loose bolts. Repair the damaged parts, tighten the loose bolts.
- Check for damage to gauges and indicators and loose bolts. Replace the damaged parts, clean off any dirt on the surface.
- Check for any loose mounting bolts of air cleaner, and tighten if necessary.
- Check for any loose terminals, and tighten if necessary.
- Clean the cab window to ensure good visibility.

3.1.2 Check Before Starting

Always carry out following items before starting the engine each day.

3.1.2.1 Check Coolant Level, Add Coolant

 WARNING
<p>Normally, do not open the radiator cap. Always wait for the engine to cool down before checking the coolant level.</p>

Open radiator cap and check the coolant level. If the level is low, add water to Full, and tighten the cap.

3.1.2.2 Check Fuel Level, Add Fuel

 WARNING
<p>Never let the fuel overflow when adding oil. This may cause fire. If fuel spills out, thoroughly clean it off.</p>

- Check fuel level by oil mark. If the level is lower than down limit, add fuel.
- Open filler cap, and add fuel through filler.
- Tighten the cap after filling.

3.1.2.3 Check Oil Level In Engine Oil Pan, Add Oil

- Open the right side cover of engine hood.
- Remove the dipstick and wipe it clean with cloth.
- Insert the dipstick back and remove it again.
- The oil level should be between the H and L marks on dipstick.

If the level is lower than L, add oil through filler.

- If the level is higher than H, check and remedy the faults.
- If the level is correct, insert the dipstick back and close the side door.

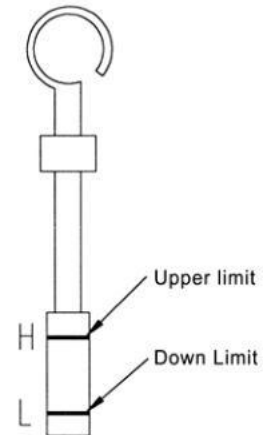

When checking the oil level after engine running, stop the engine, wait for 15 minutes and check the oil level. Park the machine on level ground before checking the oil level.

3.1.2.4 Check Transmission Oil Level

- Check the transmission oil level, which should not be lower than upper check plug, considering the oil volume in the oil lines between Torque convertor and transmission.
- When the engine is running at the constant speed (about 1000r/min). If the oil temperature is 80-110°C, the oil level should not be lower than the oil check plug, which is located at the right side of the transmission.

3.1.2.5 Check Electric System

 WARNING
<ul style="list-style-type: none"> ● If fuses are frequently blown or if there are traces of short circuit on electric wiring, locate the causes and carry out repair. ● Accumulated flammable material (dead leaves, twigs, grass, etc) around battery may cause fire. Always check and remove these materials.

Check for damage and any sign of disconnection or short circuit in electric wiring. Check and tighten the loose terminals. Check following items carefully:

- Battery
- Starting motor
- Alternator

During walk-around checks or checks before starting, always check and remove the flammable material accumulated battery.

3.1.2.6 Check Effect Of Parking Brake

Measurement condition

- Tire inflation pressure: Specified pressure
- Road surface: Dry paved surface with 1/5 grade.
- Machine: Operation condition.

Method of measurement

- Start the engine, set the machine facing straight to the front, and then drive it up a 1/5 grade, with empty bucket.

- Press the brake pedal, set Gearshift control lever to neutral position, then stop the engine.

- Press the Parking Brake Switch, release the pedal slowly, and confirm the machine is held in position.

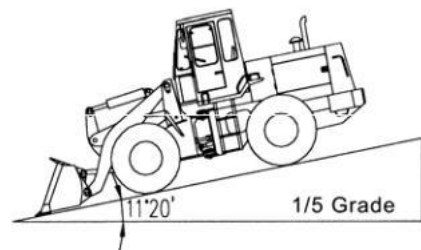
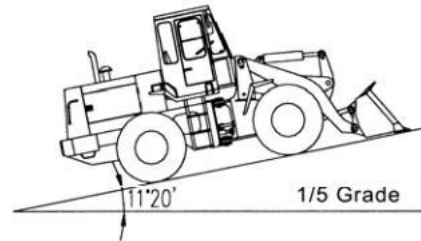

Check the Parking Brake

3.1.2.7 Check Effect of Brake

Drive the machine at a speed of 24km/h, on a dry flat concrete road. The stopping distance is less than 9m.

3.1.2.8 Other Checks

- Check the sound of the horn.
- Check for flashing of lamps, check for dirt and damage.
- Check engine exhaust color and sound.
- Check the operation of gauges.
- Check the steering operation.
- Check the rear view mirror for damage and dirt.

3.1.3 Adjust Before Operating in the Cab

WARNING

- Park the machine in a safe place and stop the engine when adjusting the operator's seat.
- Adjust the seat before starting operation or when changing operators.
- Check that you can depress the brake pedal fully with your back against the seat backrest.

- Adjust the seat back and forth

Pull the lever located at the left side out to move the seat to proper position.

- Adjust seat height

There is a button at both left and right side of the seat. Turn the button anti-clockwise and release it to adjust the height of the seat. Turn it clockwise to lock it after adjustment.

There is a button behind the seat, and the operator can turn the button in clockwise or counter clockwise according to his/her weight. Turn it in anti-clockwise when the operator is thin, and in clockwise when the operator is heavy.



3.1.4 Adjust Rear View Mirror

Sit in operator's seat and adjust the rear view mirror so that you can see properly to the rear.

3.1.5 Operations And Check Before Starting The Engine

- Check that Parking Brake Lever is at Brake position.
- Check that Gearshift control lever is at Neutral position.
- Lower the bucket to ground, and check that Work Equipment Control Lever is at Hold position.
- Insert the key to Starting Switch and turn it to ON position.
- Check whether Power Indicator is on.

3.2 Starting The Engine



WARNING

Confirm that nobody near the machine, ring the horn for warning and start the machine.

Notice:

- Do not keep the starting motor rotating continuously for more than 15 seconds.
- If the engine will not start for the 1st time, wait for at least 2 minutes before trying to start again.
- Depress accelerator pedal lightly. Turn the key in Starting Switch to Start position to start. When engine is started, release the key of Starting Switch, and it will return back to ON automatically.

3.3 Operations And Check After Starting Engine

After starting the engine, do not immediately start operations. Depress accelerator pedal slightly and run the engine without load at midrange speed for about 5 minutes.

Notice:

- Do not suddenly accelerate the engine during warming -up operation.
- Never run the engine at low idling or high idling continuously for more than 20 minutes.

- apply a load from time to time and run the engine at a midrange speed (Neutral gear).

To warm up the hydraulic oil in cold area, do as follows:

During the warming up operation, check that the engine rotation is smooth, and then operate the Bucket Control Lever inwards and outwards to warm up the hydraulic oil. The relief time at the tilt position should be less than 10 seconds. With this operation, the oil will reach the relief pressure and this will warm up the hydraulic oil quickly.

After warming up operation, check whether the gauges and caution lamps are normal. If there is any abnormality, carry out repair and recheck. Run the engine at low load till Engine Coolant Temperature Gauge, Torque Converter Oil Pressure Gauge and Barometer are in the green range.

Check whether there is no abnormality in the exhaust color, sound or vibration. Carry out repairs if any abnormality.

3.4 Moving Machine Off



- When moving the machine off, check that surrounding area is safe, sound the horn before starting. Do not allow people near the machine. There is blind spot behind the machine, so be particularly careful when traveling in reverse.

- Release parking brake before moving off the machine.

- Operate Lift Arm and Bucket Control Lever, set the work equipment to carrying position.

- Release the Parking Brake Lever to release the parking brake.

- Set the Gearshift control lever to desired position.

- Depress the accelerator pedal to move the loader.

3.5 Changing Gear Speed

 WARNING
<p>When traveling at high speed, do not change the gear speed suddenly. When shifting gear, use brake to reduce the travel speed, and then shift gear.</p>

Operate the Gearshift control lever to desired position.

3.6 Turning

 WARNING
<ul style="list-style-type: none"> ● It is dangerous to turn the machine suddenly at high speed or on turn steep hills. ● If the engine stops when the machine is traveling, the steering can not be used. Never stop the engine when traveling on slopes, because it is rather dangerous. If the engine stops, park the machine immediately at a safe place.

When traveling, use the steering wheel to turn the machine.

Front and rear frame of the machine is jointed by center pin. The front and rear frames bend at the joint point. Turn the steering wheel properly for steering.

3.7 Braking

 WARNING
<ul style="list-style-type: none"> ● Avoid sudden brake. Leave ample room when stopping. ● Do not park the machine on slopes. If the machine has to be parked on a slope, set it facing directly down the slope, then dig the bucket into ground and block the wheels to prevent the machine from moving. ● Never touch Work Equipment Control Lever.

- Release the accelerator pedal and depress the brake pedal.
- Set the Gearshift control lever to Neutral position.
- Press the Parking Brake switch to apply parking brake.

Notice:

Never use the parking brake switch to brake the machine when traveling except in an emergency. Apply the parking brake only after the machine has stopped.

3.8 Operation Of Work Equipment

Work.Equipment Control Lever can be used to operate the lift arm and bucket as follows:

- Lift Arm Control Lever

Raise: The lift arm up.

Hold: Keep the lift arm at certain position.

Lower: Lift arm down.

Float: Lift arm moves freely under external force.

Notice:

When lowering the bucket, do not use the Float position.

- Bucket Control Lever

Tilt: Tilt the bucket back.

Hold: Keep the bucket at certain position.

Dump: Dump the material down.

3.9 Work Possible Using Wheel Loader

! WARNING

Always set the machine facing directly to the front when carrying out digging or loading operation. Never carry out this operation with the machine articulated.

In addition to the following, it is possible to further increase the range of application by using various attachments.

3.9.1 Digging Operations

Notice:

If the tires slip, the tire life will be reduced. Always keep the jobsite flat and remove any fallen rocks during operation

3.9.1.1 Loading Piled Soil Or Blasted Rock

When loading piled soil or blasted rock, face the machine directly to material pile, and do as following:

- Drive the machine forward and lower the bucket, stop the bucket at about 30cm from the ground, then lower it slowly.

If the bucket hits the ground, front tires will come off the ground, and tires will slip.

- Decrease the speed when approaching the stockpile, and depress the accelerate pedal at the same time to penetrate the

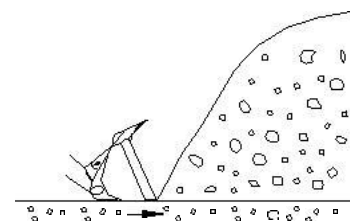
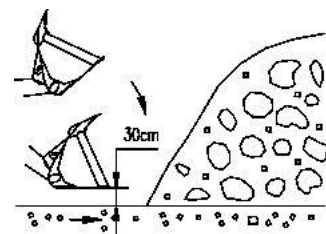

Stockpile

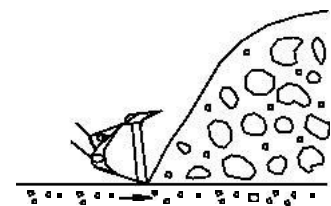

Blasted Rock

bucket in the stockpile.

- Keep the bucket horizontal to the ground; when loading light material, and tilt the bucket down slightly when loading blasted rock.

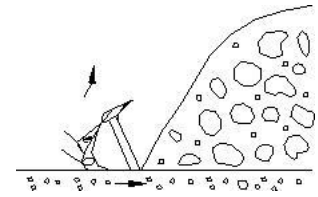

Notice:

Be careful not to get blasted rock under the bucket. This will make front tires come off the ground, and tires will slip. Try to keep the load in the center of bucket; if the load is on one side of the bucket, the load will be unbalanced.

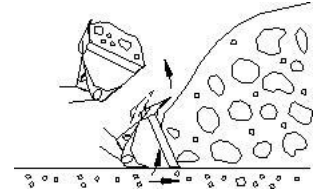

- When thrusting the bucket into the material, raise the lift arm to prevent the bucket from going in too far. By raising lift arm, ample traction will be produced by front tires.

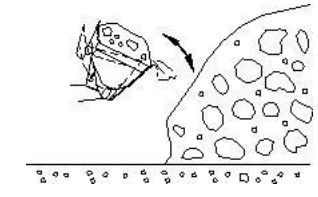

- When enough material is loaded into the bucket, operate the Work Equipment Control Lever and load the bucket fully.

Remark:

If the bucket edge is moved up and down while pushing in the bucket and digging, front tires will come off the ground, tires will slip.

- If there is too much material loaded in the bucket, dump and tilt the bucket quickly to remove the excessive load.

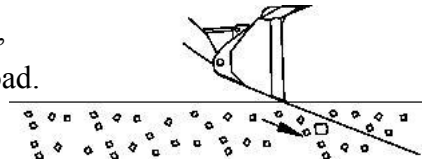

3.9.1.2 Digging And Loading On Level Ground

When digging and loading on level ground, set the bucket edge facing down slightly as follows and be careful not to load the bucket on one side and cause an unbalanced load. This operation should be carried out in 1st gear.

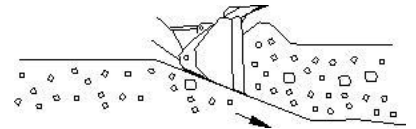

- Set the edge of the bucket facing slightly down.
- Drive the machine forward and operate the Work Equipment Control lever to lower the lift arm and cut a thin layer of the surface each time when excavating the soil.

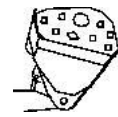

- Operate the Work Equipment Control lever back and forth to reduce the resistance when driving the machine forward.

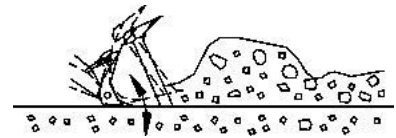

Notice:

When digging with the bucket, avoid imposing the digging force onto only one side of the bucket.

3.9.2 Leveling Operation

- Scoop the soil into the bucket. Move the machine backward while spreading soil from the bucket little by little.
- Touch the ground with the bucket teeth and level the ground by back-dragging.
- Scoop some more soil into the bucket, put the lift arm in float, level the bucket at ground level, and smooth the ground by moving backward.

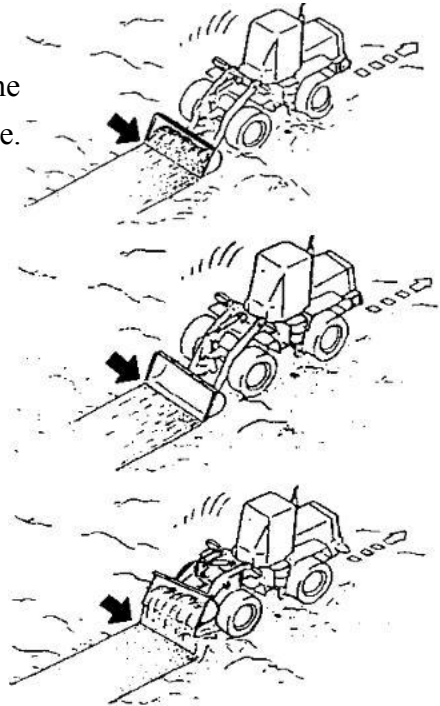

3.9.3 Pushing Operation

Notice:

Never set the bucket to the Dump position during pushing operation.

3.9.4 Load And Carry Operations

The load and carry method for wheel loaders consists of a cycle of scooping--carrying--dumping (to warehouse, glory hole, etc.)

Always keep the bucket at carrying position (40cm from ground level) during transporting the materials, and keep road clean.

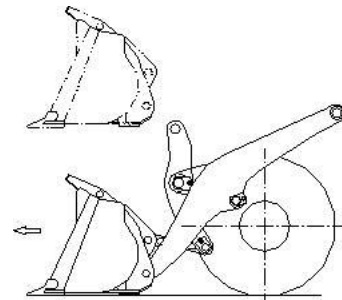

3.9.5 Loading Operations

Select the optimum method of operation that need minimum steering and travel according to the jobsite.

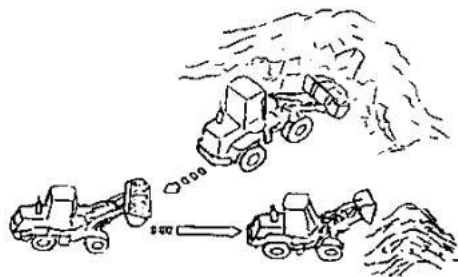

WARNING

- Always keep the working area flat. Do not turn or brake suddenly, which is dangerous.
- It is also dangerous to drive the bucket at high speed into stockpile at high speed.

Notice:

Avoid slip of the tires and excessive shaking of the bucket during operation.

- Cross Drive Loading

Always set the wheel loader facing at a right angle to the stockpile. After scooping up the load, drive the machine straight back in reverse, then bring the dump truck in between the stockpile and loader. This method requires the least loading time, and is effective in reducing the cycle time.

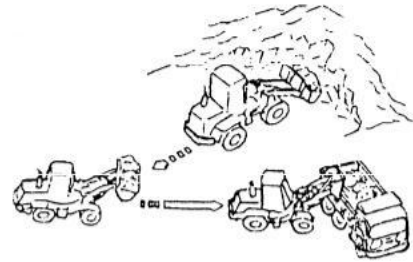
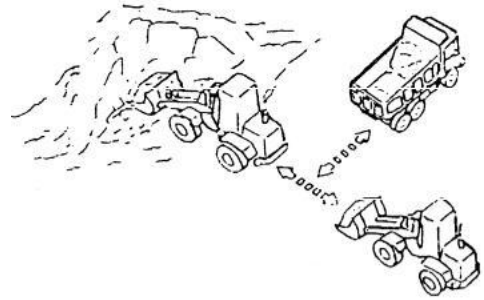

- V-Shape Loading

Position the dump truck so that the direction of approach of the loader is approx. 60° from the direction of approach to the stockpile. After loading the bucket. Drive the loader in reverse, then turn it to face and drive to the dump truck.

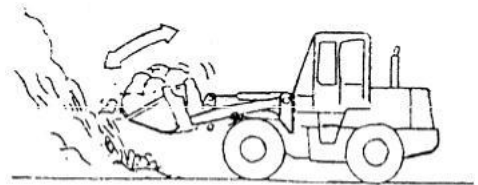

The smaller the V angle is, the more efficient the operation becomes.

When raise the full bucket to transportation height, shake the bucket to stabilize the load to prevent load from spilling during travel.

- Precautions when piling up loads

When forming products into a pile, prevent counterweight from contacting with the ground. Do not set the bucket to Dump position during piling -up operation.

- Never raise the lift arm to the highest position for digging operation.

3.10 Precautions For Operation

3.10.1 Permissible Water Depth

When working in water or swampy ground, do not let the water come above the bottom of axle housing. After finishing operation, wash, check the lubricating points.

3.10.2 If Wheel Brake Does Not Work

If the machine is not stopped by depressing the brake pedal, apply parking brake to stop the machine.

3.10.3 Precautions when driving up or down slopes

- Lower the center of gravity before turning.
- when turning on slopes, lower the work equipment to make its gravity center lower than that of machine. It is dangerous to turn the machine with work equipment raised.
- Braking on downhill

If apply brake frequently during traveling downhill, the brake may overheat. Shift down when traveling downhill.

- If engine flameout

If engine flameout on a slope, depress the brake pedal, lower the bucket and pull up the Parking Brake Lever. Set the Gearshift control lever to Hold position, and restart the engine.

3.10.4 Precautions When Driving Machine

When the machine travels at high speed for a long distance, the tires becomes extremely hot, and causes early wear of tires, so it should be avoided as far as possible. If the machine must be driven for a long distance, take the following precautions:

- Follow the vehicle operation regulations and drive carefully.
- Carry out inspection before driving.
- Adopt proper inflation pressure and travel speed according to road conditions.

When traveling on a paved road with standard tires, suitable pressure and speed are as following:

Tire Pressure: Front 0.333~0.353 MPa

Rear 0.275~0.294 MPa

Speed: 20~30 km/h

- Check the tire pressure before starting, when the tire is cool.

After traveling for 1 hour, stop check the tires and other parts for damage. Check oil and coolant level.

- Always travel with empty bucket.
- Avoid dry slag from wedging into tire.

3.11 Parking Machine

 WARNING
<ul style="list-style-type: none"> ● Avoid sudden stopping. Leave ample room for stopping. ● Never stop on slopes. <ul style="list-style-type: none"> ● If the machine has to be parked on a slope, set it facing directly downhill, dig the bucket into ground and block the wheels to stop the machine from moving. ● Sudden movement of the machine caused by hitting the control levers may lead to serious accident. Set the levers to Hold or Neutral positions, and apply parking brake.

Notice:

Never use the parking brake to stop the machine except in emergency. Apply parking brake only after stopping the machine.

- Release accelerator pedal, depress brake pedal.
- Set the Gearshift Control Lever to Neutral position.
- Press parking brake switch to stop the machine.
- Operate Lift Arm Control Lever to lower the bucket on ground, then set it to Hold.

3.12 Checks After Completion Of Operation

Check coolant temperature, oil pressure, and torque converter oil temperature and fuel level. If the engine has overheated, do not stop it immediately. Run the engine at low speed to allow it cool gradually, and then stop it.

3.13 Stop Engine

If the engine is abruptly stopped before it has cooled down, its life may be greatly shortened. Avoid abruptly stopping engine except in emergency.

If the engine has overheated, do not stop it immediately. Run the engine at low speed to allow it cool gradually, and then stop it.

- Run the engine at low idle speed for about 5 minutes to allow it cool gradually.
- Pull up the Parking Brake Lever, stop the engine and turn the key to OFF.
- Remove the key from Starting Switch.

3.14 Check After Stopping Machine

- Walk around the machine and check the work equipment, body and frames. Check for

leakage of water and oil. Repair the abnormality and leakages.

- Full the fuel tank.
- Remove any mud stuck to the machine.

3.15 Locking

Lock the cab door.

3.16 Handling The Tires

3.16.1 Precautions When Handling Tires

Replace the tire when following happens:

- Sidewall of the tire is broken, twist or seriously worn.
- Excessive damaged tire, over 1/4 of inner layer (exclusive cord layer) is exposed.
- Over 1/3 outer layer is damaged.
- The tire is peeling.
- Radial crack has extended to inner layer.
- Deformation and wear makes to tire useless.

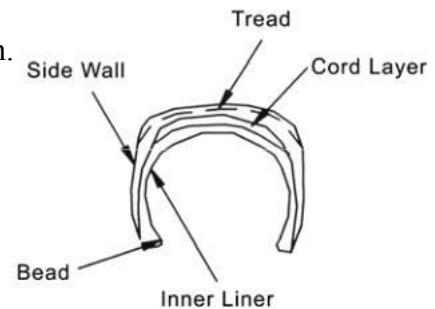

3.16.2 Tire Pressure

Measure the tire pressure before starting work, when the tires are cool. If the pressure is too low, there will be overload. If it is too high, it is easy to cause tire cut and shock burst.

4 TRANSPORTATION

When transporting the machine, observe all related regulations, and ensure safety.

4.1 Loading, Unloading Work

⚠ WARNING

- Select proper ramps to ensure safe loading, unloading.
- When loading and unloading the machine, park the trailer on a flat firm roadbed. Keep a long distance between loader and trailer.
- Remove mud from machine to prevent it from slipping on slopes. Ensure ramp surfaces clean, free of dirt.
- Never turn on the ramps. If it is necessary to change direction, drive off the ramps, correct the direction and drive on again.

When loading and unloading the machine, always use ramps or a platform and carry out the operations as follows.

- Properly block the trailer tires to ensure that it does not move. Then fix the ramps in line with the centers of the trailer and machine. Be sure that the two sides are at the same level. If the ramp sags appreciably, reinforce it with blocks.
- Determine the direction of the ramp, then slowly load or unload the machine.
- Correctly load the machine on the specified part of the trailer.

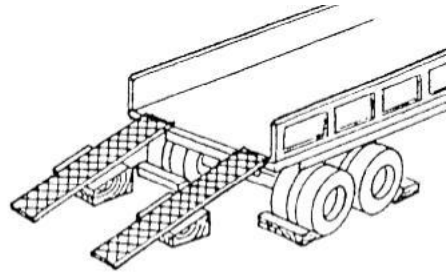

4.2 Precautions For Loading

After load the machine in the specified position, secure it in place as follows:

- Level the bucket slowly. Set levers to Hold.
- Turn the key to OFF, stop the engine and remove the key
- Lock the frames with safety bar.
- Block the tires to prevent the machine from moving during transportation.

4.3 Precautions For Transportation

 WARNING
Determine the transporting route by taking into account the width, height and weight of the machine.

Observe all regulations governing load weight, length and width.

5 COLD WEATHER OPERATIONS

5.1 Precautions For Low Temperature

If the temperature becomes low, it becomes difficult to start the engine, and coolant may freeze, so do as follows:

- Fuel and lubricant

Use fuel and oil with low viscosity for all parts.

For details of the specified viscosity, see 2.2 "USE OF FUEL, COOLANT AND

LUBRICANTS" in ChapterIV.

- Coolant

 WARNING
<p>Keep antifreeze fluid from an open fire. Never smoke when using antifreeze.</p>

Notice:

Do not mix one brand of antifreeze with different brand.

- Battery

 WARNING
<ul style="list-style-type: none"> ● To avoid gas explosions, keep battery from fire. ● Battery electrolyte is dangerous. If it gets into eyes or on skin, wash it off with large amount of water and consult a doctor.

5.2 Precautions After Completion Of Work

To prevent mud or water from freezing and disturbing starting the machine on the next morning, always observe following precautions:

- Remove mud and water from machine completely, preventing them from getting into sealing part and affecting sealing performance.
- Park the machine on hard, dry road or wooden boards. This help to protect the tracks from being frozen in the soil and easy to start on following morning.
- Open drain valve and drain coolant from radiator and engine to prevent from freezing. (Except the coolant is added with antifreeze).
- As the battery capacity drops markedly in low temperatures, remove the battery and keep it in warm place. Install it again the next morning.

5.3 After Cold Weather

When weather becomes warmer, replace fuel and oil for all parts with oil of viscosity specified

For details of the specified viscosity, see 2.2 "USE OF FUEL, COOLANT AND LUBRICANTS" in ChapterIV.

6 LONG-TERM STORAGE

6.1 Before Storage

When putting the machine in storage for a long time, do as follows:

- After every part is washed and dried, house the machine in a dry building. Never leave it outdoors.

If the machine must be outdoors, park it on well-drained concrete and cover it with canvas.

- Fill the fuel tank, lubricant and change oil before storage.
- Apply a thin coat of grease to hydraulic piston rods.
- disconnect the negative terminal of the battery and cover it, or remove it from the machine and store it separately.
- If the ambient temperature is expected to drop below 0°C, drain the coolant out (except added with antifreeze).
- Lower the bucket to ground, set Work Equipment Control Lever to Hold, Pull up Parking Brake Control Lever and lock the cab door.

6.2 During Storage

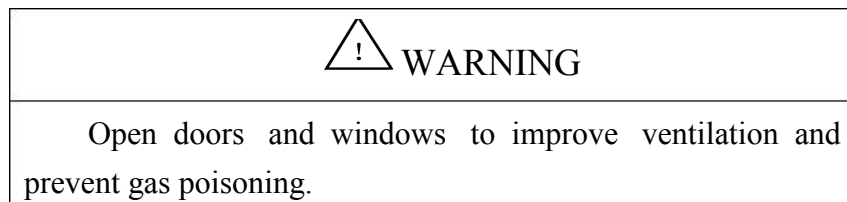

Operate the machine once a month so that a new film of oil will be coated over movable parts and components surfaces and charge the battery.

Wipe off the grease coated on the hydraulic piston rods before operation.

6.3 After Storage

Carry out following procedure when taking the machine after long-term storage.

- Wipe off grease from the hydraulic cylinder rods.
- Add oil and grease to all places.

7 TROUBLESHOOTING

7.1 When Machine Run Out Of Fuel

 WARNING
Check that the area around the engine is normal before cranking the engine.

If the machine has run out of fuel, add fuel then bleed air from fuel system before starting the engine.

Procedures for bleeding air:

- Loosen the bleeding screw on high-pressure pump.
- Bleed air with hand pump, till there is no air bubble coming out of bleed hole.
- Bleed the air for 3~5 seconds continuously.
- Tighten the screw.
- The air can be bled more quickly if the fuel tank is full.

7.2 Towing The Machine

 WARNING
<ul style="list-style-type: none">● If a troubled machine is towed on a bad road, it may lead to serious damage or injury.● If there is a failure in brake line, the brake cannot be used, be extremely careful when towing.

Notice:

Towing is to move the machine to a place for inspection and maintenance, and not for moving it for long distance. The loader cannot be towed except in emergency. Tow a machine as follows:

- When the machine cannot brake, block the wheels to prevent the machine from moving suddenly.
- Tow the machine at a speed of 2km/h, and tow it to a place for repair as near as possible.
- If the machine must be moved for a long distance, carry it with trailer.
- Fit a guard plate to the machine being towed to protect the operator if the tow rope or

bar break.

- If the steering and brake of the towed machine cannot be operated, do not let anyone sit on the machine.

- Check that the towrope or bar is of ample strength for the weight of the machine being towed. If the towed machine must travel through mud or up hills, use a towrope or bar with strength of at least 1.5 times the weight of the towed machine.

- Keep the angle of the towrope as small as possible. Keep the angle between the centerlines of two machines within 30°. Start the towing machine slowly with proper speed.

- The towing machine should normally be of the same class as the machine being towed. Check that the towing machine has ample braking power, weight, rim-pull to allow it control both machines on slopes or on tow road.

- When towing a machine downhill, use a larger machine for towing to provide ample rim-pull and braking force, and connect another machine to the rear of towed machine to prevent machines from losing control and tipping over.

- Relieve the parking brake during towing.

7.2.1 When Engine Can Be Used

- If the transmission and steering wheel can be operated, and the engine is running, it is possible to tow the machine out of mud or move it to road edge.

- The operator should sit on the towed machine during towing.

7.2.2 When Engine Cannot Be Used

Use the following procedures when towing a machine with engine stopped:

- Remove front and rear driving shafts. Block the wheels when necessary to prevent machine from moving.

- Remove the front and rear driving shafts and block the tires when necessary to prevent the machine from moving.

- If the steering cannot be operated, remove the steering cylinders. Only apply for several times even if the brake can be operated.

- Connect the towing equipments securely. When carrying out towing operations, use two machines of at least the same class as towed machine. One is connected to front, and the other is to the rear, and remove the blocks under tires.

7.3 If Battery Is Discharged

WARNING

- When checking or handling batteries, stop the engine and turn the key to OFF.
- Use a wet cloth to wipe off the dust accumulated on the surface before starting the engine.
- The battery generates hydrogen gas, so it is danger of explosion. Do not bring fire near battery, to avoid sparks.
- Battery electrolyte is dilute sulphuric acid and will attack your clothes and skin. If it gets in your eyes, wash it out with fresh water, and consult a doctor.
- Always wear protective goggles when handling battery.
- When removing battery, first disconnect the cable from the ground (blue terminal). When installing, install positive terminal first (red). If a tool touches the positive terminal and chassis, there is danger that it will cause sparks.
- If the terminals are loose, there is danger that the defective contact may generate sparks that will cause an explosion. When installing the terminal, install them tightly.
- When removing or installing, identify positive and negative terminals.

7.3.1 Removal And Installation of Battery

When remove and install batteries, do as follows:

- When removing battery, first disconnect the cable from the ground (normally from the negative terminal), and connect positive terminal when installing. If a tool touches a cable connecting the positive terminal and chassis, there is danger of sparks being emitted.
- When installing battery, the ground cable should be connected to the ground terminal as the last step.

Remark:

The batteries are on both sides at the rear of the machine. The battery used for the ground is on the right side of the machine.

7.3.2 Precautions For Charging Batteries

- Before charging, disconnect the cable from the negative terminal of the battery. Otherwise, an unusually high voltage will damage the alternator.
- While charging the battery, remove all battery plugs for satisfactory ventilation. To avoid gas explosions, do not bring fire or sparks near the battery.
- If the electrolyte temperature exceeds 45°C, stop charging for a while.

● Turn off the charger as soon as the battery is charged. Overcharging the battery may cause the following:

Overheating the battery.

Decreasing the quantity of electrolyte.

Damaging the electrolyte plate.

● Do not mix the cables (mix between positive and negative connections), as it will damage the alternator.

● When checking electrolyte level and gravity, disconnect cables from the battery.

7.3.3 Starting Engine With Booster Cable



● When connecting the cables, never contact the positive and negative terminals.

● When starting the engine with a booster cable, always wear safety glasses.

● Be careful not to let the normal machine and problem machine contact each other.

This prevents sparks near battery which could ignite the hydrogen gas given off by the battery and cause serious accident.

● Make sure that there is no mistake in the booster cable connections. When connecting the engine block of problem machine finally, connect to a place as far as possible from the battery to prevent sparks.

● Be careful not to allow the cable ends to contact each other or the machine, to avoid hydrogen explosion.

Notice:

● The size of the booster cable and clip should be suitable for the battery size.

● Battery of normal machine must be the same capacity as that of the engine to be started.

● Check the cable and clips for damage or corrosion.

● Make sure that the cables and clips are firmly connected.

Do as follows to start the engine with booster cable.

Connecting the booster cables:

Keep the starting switch at the OFF position, and connect the booster cable as follows, in the order of numbers marked in the diagram:

- Make sure that starting switches of normal machine and problem machine are both at OFF positions.

- Connect one clip of booster cable (A) to positive terminal of the problem machine.

- Connect the other clip of the booster cable (A) to positive terminal of the normal machine.

- Connect one clip of booster cable (B) to negative terminal of normal machine.

- Connect the other clip of booster cable (B) to positive terminal of problem machine.

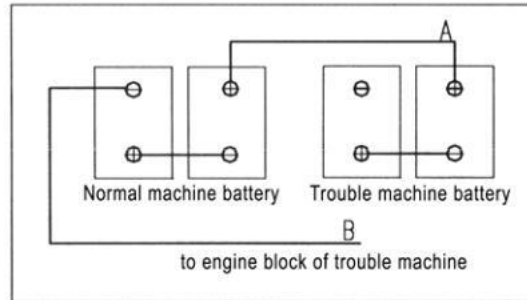

Starting the engine:

- Make sure that clips are firmly connected to battery terminals.
- Turn the starting switch of the problem machine to start the engine. If the engine does not start at first time, wait for at least 2 minutes before trying again.

Disconnecting The Booster Cable

After the problem machine has started, disconnect the booster cables in the reverse order in which they are connected.

- Remove one clip of booster cable (B) from the engine block of the problem machine.
- Remove the other clip of booster cable (B) from the negative terminal of the problem machine.

- Remove one clip of booster cable (A) from the positive of the normal machine.
- Remove the other clip of booster cable (A) from the positive of the normal machine.

7.4 Other Troubles

- Always contact with the manufacturer when dealing with these items.
- In cases of abnormalities or causes which are not listed below, please contact with the manufacturer and dealers.

7.4.1 Electrical System

No.	Problems	Main Causes	Remedy
1	Lamp does not glow brightly even when the engine runs at high speed	1. Defective wiring	Check, repair loose terminals, and disconnection. Adjust fan belt tension.
2	Lamp flickers while engine is running	2. Defective adjustment of fan belt tension	For details, see "Operation and Maintenance Manual" of diesel engine.
3	Ammeter does not work when engine running	1. Defective alternator 2. Defective wiring 3. Improper adjustment of belt tension	1. Replace 2. Check and repair 3. Adjust belt tension. For details, see "Operation and Maintenance Manual" of diesel engine.
4	Abnormal noise from alternator	Defective alternator	Replace
5	Starting motor does not turn when starting switch is on	1. Defective wiring 2. Insufficient battery charge	1. Check and repair 2. Charge
6	Pinion of starting motor does not mesh or keep meshing but doesn't rotating	Insufficient battery charge	Charge
7	Starting motor turns engine sluggishly	1. Insufficient battery charge 2. Defective alternator	1. Charge 2. Replace
8	Starting motor disengages before engine starts	1. Defective wiring 2. Insufficient battery charge	1. Check and repair 2. Replace

7.4.2 Transmission System

No.	Problems	Main Causes	Remedy
1	Shifting pressure of every speed range is low	<ol style="list-style-type: none"> 1. Over low oil level in transmission oil sump 2. Oil leakage from main oil lines 3. Transmission oil filter is clogged 4. Failure of converter charging pump 5. Improper adjusting to pressure-regulation valve in transmission control valve 6. Invalid spring of pressure-regulation valve in transmission control valve 7. Pressure-regulation valve of transmission control valve or accumulator piston is blocked 	<ol style="list-style-type: none"> 1. Supply oil to set level 2. Check the main oil lines 3. Clean or replace the filter 4. Disassemble and check or replace the converter charging pump 5. Adjust to settled 6. Change spring of pressure regulation valve 7. Disassemble, check the reason and remove the phenomenon
2	Shifting pressure of certain speed range is low	<ol style="list-style-type: none"> 1. Piston seal ring of this range is damaged 2. Seal ring in oil line of the range is damaged 3. Oil leakage of oil line for this range 	<ol style="list-style-type: none"> 1. Change the seal ring 2. Change the seal ring 3. Check and remove the leakage
3	Over high oil temperature of torque converter	<ol style="list-style-type: none"> 1. Over low oil level in transmission oil sump 2. Too high oil level in transmission oil sump 3. Shifting pressure is low and clutch slips 4. T/Q radiator is clogged 5. T/Q operates with high load for a continuous long time 	<ol style="list-style-type: none"> 1. Supply oil to set level 2. Drain oil to set level 3. Refers to faults 1 and 2 4. Clean or replace the radiator 5. Stop operation for cooling properly
4	Loader can not move while engine runs in high speed	<ol style="list-style-type: none"> 1. Cut-off valve spool of transmission can't reset 2. Not shift to a speed range 3. Spring of pressure-regulation valve in transmission valve is broken 4. Same as 1,2,3,4 of fault 1 	<ol style="list-style-type: none"> 1. Disassemble the cut-off valve, check out the reason and remedy 2. Shift to a certain range or readjust the control levers and linkages 3. Change the spring 4. Refers to 1,2,3,4 of fault 1
5	Insufficient driving force	<ol style="list-style-type: none"> 1. Shifting pressure is low 2. Over high oil temperature of T/Q 3. Damaged T/Q blades 4. Damaged free wheel clutch. 5. Insufficient driving force from engine 	<ol style="list-style-type: none"> 1. Refers to faults 1 and 2 2. Refers to fault 3 3. Disassemble and check the Torque converter, change blades 4. Disassemble and check freewheel clutch, change damaged parts 5. Check and service the engine

7.4.3 Brake System

No.	Problems	Main Causes	Remedy
1	Insufficient brake force	<ol style="list-style-type: none"> 1.Oil leakage of pliers' piston 2.Air in brake hydraulic lines 3.Low braking air pressure 4.Damaged booster leather cup 5.Oil leakage from hub drops to brake plates 6.Brake plates are worn to the limit 	<ol style="list-style-type: none"> 1.Change rectangular seal ring of pump 2.Bleed the air out 3.Check the sealing condition of air compressor, control valve storage tank and lines 4.Change the leather cup 5.Check or replace seals for hub 6.Change brake plates
2	Impossible to disengage the brake	<ol style="list-style-type: none"> 1.Wrong position of brake valve spool; blocked piston rod, damaged or invalid reset spring 2. Improper operation of booster 3.Pump piston of pliers can not reset 	<ol style="list-style-type: none"> 1.Refers to 2. 2.Check the booster pump 3.Check or replace the rectangular seal ring
3	Pressure in air storage tank drops quickly after parking (pressure drop is over 0.1 Mpa in 30 min.) and oil	<ol style="list-style-type: none"> 1.Inlet valve of air brake valve is clogged by dirt or damaged 2.Loose pipe fitting or broken pipes 3.Poor sealed unilater alism valve in water separator combined valve 	<ol style="list-style-type: none"> 1.Brake for continuous several times to blow the dirt off 2.Tighten the pipe fitting or change brake pipes 3.Check out the reason for sealing failure and change when necessary
4	Slow rise of pressure reading from the brake barometer	<ol style="list-style-type: none"> 1.Loose pipe fitting 2.Abnormal working condition of air compressor 3.Inlet valve or diaphragm of brake valve is not sealed 4.Air leakage from bleed plug or retaining valve and diaphragm of pressure controller 	<ol style="list-style-type: none"> 1.Tighten the fitting 2.Check working condition of air compressor 3.Check and clean the inner part of brake valve, find out the unsealed part and repair 4.Clean air bleed hole, find out the unsealed reason for retaining valve and diaphragm then repair

7.4.4 Work Equipment Hydraulic System

No.	Problems	Main Causes	Remedy
1	Insufficient raising force of lift arms	<ol style="list-style-type: none"> 1. Oil seals for cylinders are worn or damaged 2. Over wear in multiply valve, clearance between valve spool and valve block is over set value 3. Oil leakage from oil lines 4. Severe inner leakage of working (steering) pump 5. Idle suction of working (steering) pump 6. Adjustment system to safety valve and system pressure is over low 7. Clogged suction tube and filter 	<ol style="list-style-type: none"> 1. Change the cylinder seals 2. Change the multiply valve 3. Find out the leaking points and repair 4. Change the oil pump 5. Check oil lines and remedy 6. Regulate the system pressure to set value 7. Clean the filter and change oil
2	Insufficient force of the bucket, the bucket tend to lowering down or float	<ol style="list-style-type: none"> 1. Damaged seal ring of steering cylinder piston 2. Over wear in multiply valve. Clearance between valve spool and valve block is over the set value 	<ol style="list-style-type: none"> 1. Change the seal 2. Replace the valve
3	Hydraulic oil mixing into transmission	Aged or broken oil seals of working (steering) oil pump and steering pump	Change oil seals or oil pump
4	Foam in hydraulic oil reservoir and abnormal noise	<ol style="list-style-type: none"> 1. Damaged suction oil line or air leakage. Air is sucked into oil lines. 2. Over low oil level, large amount of air is sucked into oil lines. 	<ol style="list-style-type: none"> 1. Check the oil lines, remedy the leakage points. Replace when necessary. 2. Add oil to specified level.

7.4.5 Steering System

No.	Problems	Main Causes	Remedy
1	Heavy steering	<ol style="list-style-type: none"> 1. Insufficient oil supply from working (steering) pump oil pump 2. Air in steering system 3. Invalid steel-ball check valve in valve block of steering unit causes heavy steering with slow or quick turning of the steering wheel, and no pressure 4. Invalid priority valve 5. Relief valve pressure is low 	<ol style="list-style-type: none"> 1. Check whether pump is normal 2. Discharge air from system and check the suction line 3. Check the valve block and clear out the clogged dirt 4. Replace priority valve 5. Readjust the pressure to specified value
2	Increased turns of steering	<ol style="list-style-type: none"> 1. Over low oil level in hydraulic reservoir 2. Oil leakage of oil lines, damaged oil seals 3. Inner leakage of steering cylinder 4. Steering unit worn. 5. High viscosity of oil or wrong brand. 	<ol style="list-style-type: none"> 1. Fill oil to set level 2. Change seals of the lines 3. Change cylinder seals 4. Replace the steering unit 5. Change with required oil
3	Malfunction or failure in steering	<ol style="list-style-type: none"> 1. Damaged spring plate of steering unit 2. Cracked, broken or deformed center pin and drive shaft 3. Malfunction of bi-directional overload valve 4. Engaged rotor and stator, engaged valve spool, valve body and sleeve 5. Malfunction of steering pump or priority valve 	<ol style="list-style-type: none"> 1. Change the damaged spring plate 2. Change the center pin or drive shaft 3. Check and repair the bi-directional over-load valve 4. Disassemble, check, clean and assemble strictly or change parts 5. Change the damaged parts
4	Steering wheel can not reset	<ol style="list-style-type: none"> 1. Not concentric steering column and valve spool 2. Steering shaft axially pushes the valve over its limit 3. Over large steering resistance of steering column 4. Broken spring plate <p>Phenomena: Pressure drop increases or steering unit is not in relief when steering wheel stops (loader deflect from straight traveling line)</p>	Remove the faults according to the respective reasons.

7.4.6 Engine

Refers to "Operation and Maintenance Manual" of diesel engine for troubleshooting.

CHAPTER IV MAINTENANCE

1 GUIDES TO MAINTENANCE

Read following information before carrying out maintenance and inspection.

Precautions before maintenance and inspection

- Perform maintenance on hard and flatten the ground.
- Lower the work equipment on the ground and level the bucket.
- Operate all control levers to Hold positons
- Pull up the Parking Brake Control Lever.
- Put blocks in front and behind the wheels.
- Lock the front and rear frames with safety bar.

Warning tag

Attach the warning tag near Starting Switch before maintenance to prevent anyone from starting the engine during maintenance.

Spare parts

Only use parts specified by the manufacturer of the wheel loader.

Oils and fuel

Use oils and fuel specified in this manual.

Always use clean oils and fuels

Keep containers of oils and fuel clean, and use clean oils and fuel.

Keep the machine clean

Always keep the machine clean. In particular, keep grease fittings, pipe joints and oil level gauges clean and avoid foreign materials from getting in them.

Be careful of hot water and oil

Draining hot oils and coolant and removing the filters immediately after the engine stops are hazardous. Allow the engine to cool. If the oil has to be drained when it is cold, warm up the oil to a suitable temperature (approx. 20~40°C) before draining.

Check oil and filters

After oil is changed or filters are replaced, check the oil and filters. If large amount of metallic particles or other materials are found, consult the maintenance personal.

Fuel strainer

Do not remove the fuel strainer while fueling.

Oil change

Change oils in the places where dust is scarce to keep foreign materials away from oils.

Welding instructions

- Turn off the engine starting switch and remove the battery cables.
- Connect the grounding cable within 1m from the area to be welded.
- Avoid welding near seal rings and bearings
- Never weld any pipe or tube containing fuel or oil

Fire prevention

Use inflammable cleaner or light oil for cleaning parts. Keep flame or cigarette light away from light oil.

Sealing parts

When replacing O-ring or gaskets, clean the clamp faces and be sure to fit O-ring and gaskets when assembling.

Checking undercarriage

When working in rocky areas, check for damage to the undercarriage and for looseness in bolts and nuts.

Precautions when washing machine

- Wash the machine after complete cooling of the engine.
- Do not allow water to spray on any electrical component.

Checking in raining and snowing circumstances

Clean the machine immediately after working in rain and snow, lubricate and coat anti-rust oil to more points.

Dusty worksite

When working at dusty worksites, do as follows:

- Inspect and clean air filter frequently to avoid blocking up.
- Clean the radiator frequently to avoid blocking up.
- Clean and replace fuel filter at short intervals.
- Clean the electrical components, especially the starting motor and alternator, to avoid accumulation of dust.

- Refers to "Operation and Maintenance Manual" of diesel engine for replacing air filter.

Avoid Using Mixed Oil

Never use oil mixed with different brands. If only 1 brand of oil is available, which is different from that in the machine. Drain the oil from the machine, and fill with new branded oil.

2 DETAILED RULES OF MAINTANLE

2.1 Outline Of Oil, Fuel And Coolant

2.1.1 Oil

- The loader is operated in extremely severe and dusty conditions (high temperature, high pressure), and it is easy to make oil deteriorates with use. Always change oil when the oil is found deteriorated or mixed with much foreign materials.

- Always add the specified amount of oil. Having too much or too little oil are both causes of problems.

- When changing oil, always clean or replace the related filters at the same time.

Change oil of transmission with following procedures to reduce the possibility of troubles caused by oil. Refers to "Operation and Maintenance Manual" of diesel engine for changing engine oils.

- Set the Gearshift control lever to Neutral position, pull up the Parking Brake Control Lever and block the wheels.

- Screw off the suction tube of transmission oil pan, drain the oil off and replace with new oil. If the drained oil is dirty, do as follows before adding oil:

- Remove the strainer, open the oil pan and clean all parts. If large amount of metallic particles or foreign materials are found, consult the maintenance personal.

- Install all parts in assembling order, add small amount of torque converter-transmission oil, start the engine and let it run for 3~5 minutes at idle speed. Stop the engine and drain the oil off after cooling down. Add with specified oil.

2.1.2 FUEL

- The fuel pump is a precision instrument, and if fuel containing water or dirt is used, it cannot work properly.

- Be extremely careful not to let impurities get in when storing or adding fuel.

- Always use the fuel specified in this manual.

Fuel may congeal at low temperature (particularly at temperature lower than -15°C), so it is necessary to change the fuel to match the temperature.

- To prevent the moisture in the air from condensing and forming water inside the fuel tank, always fill the fuel tank after completing the day's work.

- If the engine runs out of fuel or the filters have been replaced, it is necessary to bleed the air from the circuit.

2.1.3 COOLANT

- Use the clean soft water, rain or tap water as coolant. Well water and spring water can be used as coolant after boiling and precipitation to prevent scale from causing defective

heat exchange and overheating.

- If the engine overheats, wait for the engine to cool before adding coolant.
- Add coolant to specified level. If the level is low, it will cause overheating and corrosion to cooling system.
- If ambient temperature is lower than 0°C , add antifreeze to coolant. Otherwise, drain the coolant out after work and refill before next work.
- Antifreeze is flammable. Keep fire off when add antifreeze.
- Never use 100% antifreeze as coolant. Refer to following chart for mixing proportions.

Name	Proportion %					Freezing point $\leq^{\circ}\text{C}$
	Glycol	Alcohol	Glycerin	Water	Proportion	
Glycol Antifreeze	60			40	Proportion in volume	-55
	55			45		-40
	50			50		-32
	40			60		-22
Alcohol		30	10	60	Proportion in weight	-18
Glycerin		40	15	45		-26
Antifreeze		42	15	43		-32

2.1.4 Lubricant

- Lubricant is used to prevent wear and noise at joint faces.
- Joints not included in the manual (connectors, jointing sleeves) are sections to be treated for overhaul, so they do not need grease. When some parts become unflexible because of long-term operation, it is necessary to lubricate them.
- Remember to wipe off the overflow lubricant when adding grease.

2.1.5 Storage Of Oil And Fuel

- Prevent any water, dirt or other impurities from getting in.
- To prevent any change in quality during long-term storage, be sure to use in the order first in, first out (use the oldest oil or fuel first).

2.1.6 Filters

- Filters are extremely important safety parts. They prevent impurities in the fuel from entering important equipment and causing problems. Replace all filters periodically. When working in severe conditions, it is necessary to replace filters at shorter intervals.
- Never try to clean the paper elements and use them again. Always replace them with new one.
- When replacing oil filters, check if any metal particles are stuck to the old filter. If any

metal particles are found, contact with the maintenance personal.

- Do not open packs of spare filters until just before they are to be used.
- Always use genuine filters.

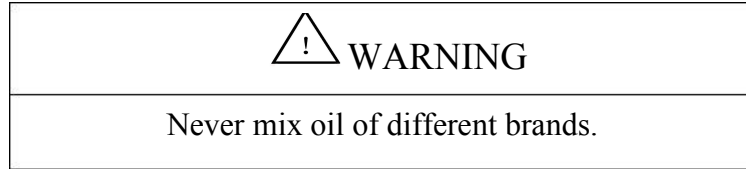

2.2 Use Of Fuel, Coolant And Lubricant

2.2.1 Reference Chart Of Fuel, Coolant And Lubricant

Select oils specified in the following chart, except in special conditions. Temperature in the chart means ambient temperature.

Kinds Of Fluids	Recommended Types And Standards	Capacity	Places
Engine oil	Ambient Temperature. $\geq -15^{\circ}\text{C}$ CD15W/40 GB11122-1997 Ambient Temperature. $< -15^{\circ}\text{C}$ CD5W/30 GB11122-1997	15L	Engine
Torque Converter oil	6# transmission oil Q/SH303 064-2004	39L	Torque Converter and Transmission
Gear oil	SAE 85W-90 GL-5 gear oil GB13895-1992	$2 \times 16\text{L}$	Axle driving and rim reducer
Hydraulic oil	Ambient Temp $\geq -5^{\circ}\text{C}$ L-HM46 Hydraulic Oil GB11118.1-1994 Ambient Temp $\geq -10^{\circ}\text{C}$ L-HM32 Hydraulic Oil GB11118.1-1994 Ambient Temp $\geq -30^{\circ}\text{C}$ L-HV46 Hydraulic Oil GB11118.1-1994	130L	Hydraulic oil tank
Fuel	Min Temp $\geq 4^{\circ}\text{C}$ 0# Light Diesel Oil GB252-1994 Min Temp $\geq -5^{\circ}\text{C}$ -10# Light Diesel Oil GB252-1994 Min Temp $\geq -14^{\circ}\text{C}$ -20# Light Diesel Oil GB252-1994 Min Temp $\geq -29^{\circ}\text{C}$ -35# Light Diesel Oil GB252-1994	140L	Fuel tank
Brake fluid	HYZ3 Brake fluid (DOT3) GB12981-2003	4L	Brake oil cup
Grease	2# or 3# Lithium based grease GB7324-1994	2.8kg	Joint points, pins of work equipment
Antifreeze	Engine coolant of Glycol type SHO521-1992		Radiator

2.2.2 Reference Chart Of Foreign And Domestic Oils

● Engine oil

Oil Brands	Similar foreign oil brands (classified by SAE standard)			
	MOBILE	SHELL	CALTEX	ESSO
Engine oil	HEIBAWANG 15W-40 (Ambient temperature: -15~50°C)	Rotella SX40: Rotella TX40, 20w/40 Rotella DX40	Custom five star Moter oil 40,20w/40 RPM delo 100,200 oil 40	Essolube XT-3 Essolube XT-2
	Delvac 1# (over -40°C) HEIBAWANG 10W-30 (-20~40°C)	Rotella SX30: 10w/30 Rotella TX30, Rotella DX30	Custom five star Moter oil 30; RPM delo 100,200 oil 30,10w/30	Essolube XT-5

● Hydraulic Oil

Domestic Brands	Kinematic viscosity (40°C) mm ² /s	Similar foreign oil brands				
		MOBILE	SHELL	CALTEX	CASTROL	ESSO
Super anti-wear hydraulic oil L-HM 46 GB11118.1-1994 (Summer)	41.4~50.6	DTE25 (-10~40°C)	Tellus27: Tellus29	Rando oil HD 32 Rando oil HD 46	Hyspin AWS 32 Hyspin AWS 46	Nuto H46
Highly ranked wear-resistance hydraulic oil L-HV46 GB11118.1-1994	28.8~35.2	DTE15M (-26~40°C)	Hydro-Kinetic Tellus T27 46	Rando oil HD AZ	Hyspin AWH 46 Nuto	Univis N 46

● Torque converter-Transmission oil (Hydraulic transmission oil)

Domestic Brands	Kinematic viscosity (100°C) mm ² /s	Similar foreign oil brands			
		MOBILE	CALTEX	ESSO	SHELL
6# Hydrostatic transmission oil	5~7	ATF Autoshifting (over -40°C) ATF 220 Autoshifting (-25~40°C)	Torque fluid 175; RPM torque fluid No.5	Torque Fluid G7	Rotella 10W

● Gear oil (Axle oil)

Domestic Brands	Kinematic viscosity (100°C) mm ² /s	Similar foreign oil brands			
		MOBILE	ESSO	CALTEX	SHELL
85W-90 GL-5 GB13895-1992	13.5~24.0	Mobilube 1SH synthetic oil (over -40°C) Automobile gear oil HD80W-90 (-20~40°C) Automobile gear oil HD85W-140 (-10~50°C)	Multi purpose Thuban Ep	Gear oil GX 85W-90	Spirax EP Heavyduty HD90 HD80w-90

● Brake oil

Domestic Brands	Class	Similar foreign oil brands			
		MOBILE	ESSO	British BP	SHELL
HZY3 Automobile brake fluid GB12981-2003	SAE 1703C	Super Brake Oil DOT3	Brake fluid	Brake fluid Disc- Brake Fluid	Donax B

● Lubricant

Domestic Brands		Similar foreign oil brands				
		MOBILE	CALTEX	CASTROL	ESSO	British BP
2# or 3# lithium based grease	Mobil XHP 222	Marfak multi Purpose	LM grease	LANGLISHI MP; Beacon EP2	Energrease L	Retinax A; Alvaniag

2.3 Lubricating Chart

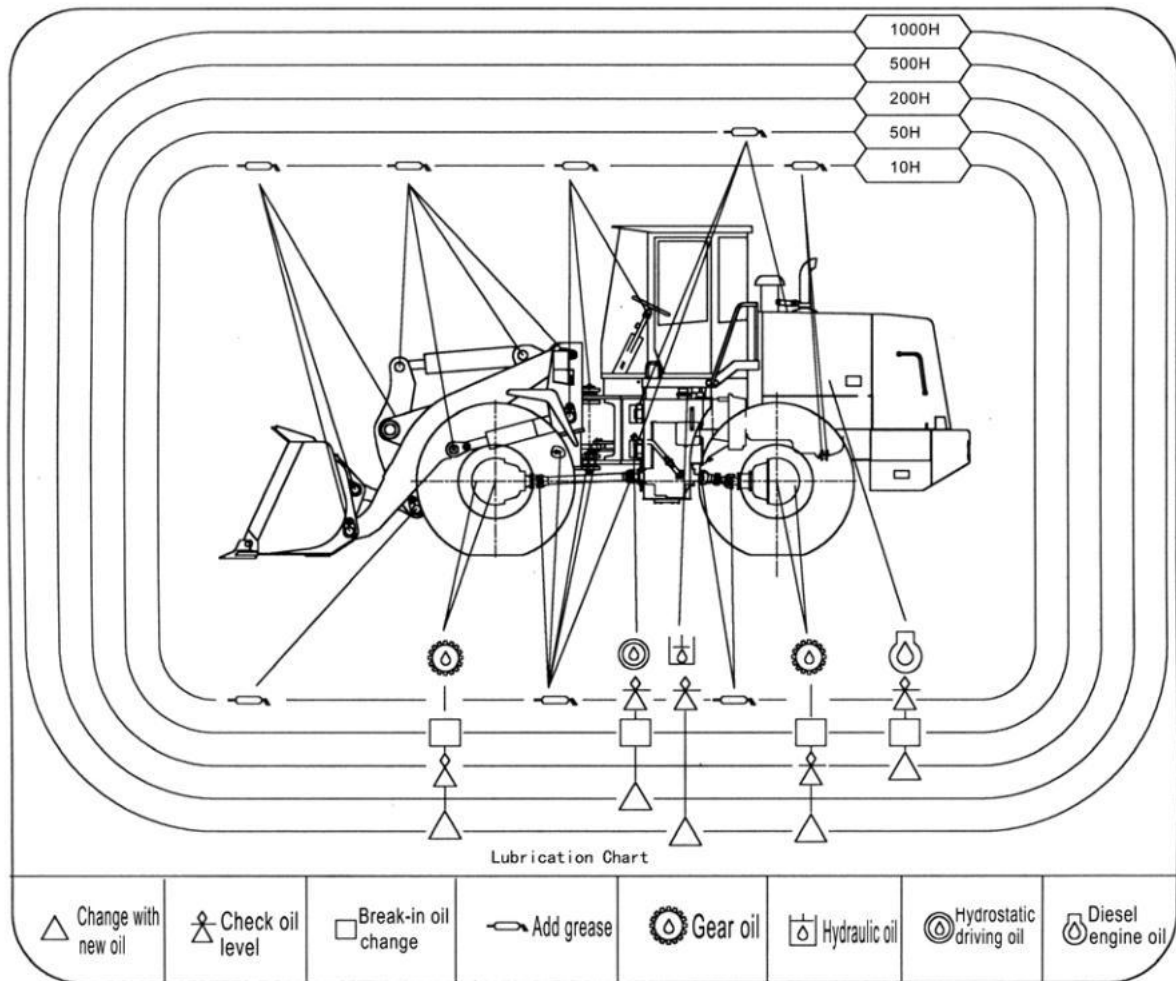

2.4 Outline Of Electric System Maintenance

- If the wiring gets wet or the insulation is damaged, the electric system leaks and this could result in hazardous accident.
- Service relating to the electric system:
 - 1) Check of fan tension
 - 2) Check of battery fluid level
- Never remove or disassemble any electric components installed in the machine.
- Never install any electric components other than those specified by the manufacturer.
- Be careful to keep the electric system free of water when washing the machine or when it rains or snows.
- When working on the seashore, carefully clean the electric system to prevent corrosion.

2.5 Maintenance Tools

Refers to the following chart for the tools delivered with the machine, which is subject to change without notice.

2.6 Tightening Torque Of Threads

Follow the specified tightening torque except in special condition.

No.	Tightening Parts	Thread size	Material	Torque (N.M)
1	Assembling bolts of transmission base	M18×40	8.8	250-275
2	Mid cover of transmission	M12×30	8.8	124-165
3	Castle nuts at both ends of the transmission output	M33×1.5	8	320-380
4	Assembling bolts of hub and brake disc	M18×1.5×50	8.8	200-250
5	Assembling bolts of differential cases	M14×2×140	40Cr	130-210
6	Assembling bolts of spiral bevel gear and flanged case	M16×53	40Cr	210-350
7	Assembling bolts of bearing cap and carrier in main reducer	M22×80	8.8	384-512
8	Lock nut of input flange in main reducer	M33×1.5	8	320-380
9	Assembling nuts of planetary gear carrier and hub	M18×1.5	10	264-354
10	Connection between main reducer carrier and axle case	M12×1.25×35	8.8	110-130
11	Rim nuts	18×1.5	8	265-355
12	Assembling bolts of brake pliers and carrier	M18×1.5×50	8.8	282-376
13	Assembling of driving axle and frame	M24×2×100 M24×2×95	8.8	400-500
14	Connection of driving shaft	M14×1.5×45	8.8	125-165
15	Connection between oil tank and frame	M16×35	8.8	185-265
16	Connection between fuel tank and frame	M20×2×60 M24×2×150	8.8	250-360 320-480
17	Connection between teeth and bucket	M16×40 M16×70	45	193-257

3 MNINTENANCE OF PROCEDURES

Maintenance procedures can be divided into break-in of new machine and periodic maintenance of every 10 hours, 50 hours, 200 hours, 500 hours, 1000 hours and 2000 hours.

3.1 Break-in Of New Machine

Break-in of new machine before normal operation should be started with idle running and increase the load gradually. Purpose of break-in of the machine is to make the friction parts fit thoroughly and prolong the working life of the machine.

Idle running (12 hours)

- Start the engine and let it run at low idle speed for 5 minutes, then accelerate gradually to highest speed for 10 minutes.
- Operate the work equipment, lift and lower the lift arm, tilt and dump the bucket for approx. 15 minutes.
- Drive the loader from low to high speed in every gear, together with stable steering and braking.
- Loading weight of the machine during break-in period should not be higher than 70% of rated value.

Carry on the following procedures after try running

- Check carefully the tightening conditions of bolts and nuts of all parts.
- Check whether there is abnormal noise.
- Check whether the gauge readings are normal.
- Check whether there is leakage.
- Check the steering and braking system for flexibility and reliability.
- Check whether the operation of work equipment is normal.
- Check the tension of fan belt.
- Check the control levers for flexibility and reliability.
- Check the battery fluid level and tighten the terminals
- Check for leakage of each sealing parts.

3.2 Periodic Maintenance

3.2.1 Every 10 Hours Service

- Check oil levels in transmission, hydraulic oil reservoir and brake booster pump.

- Check the sealing condition of work equipment hydraulic system, steering system and brake system.

- Check whether the electric wiring and electric components are normal.
- Add grease to fan shaft, pivot point of front and rear frames, driving shafts, pivot points of oscillating frame.
- Check fuel level and coolant level.
- Other checking and adjusting parts.
- Refers to "Operation and Maintenance Manual" of diesel engine for maintenance.

3.2.1 Every 50 Hours Service

Perform the service operation of every 10 hours maintenance.

- Check the tightening of assembling bolts of driving shafts.
- Check the tightening of assembling bolts of hubs and brake discs.
- Check the electric wires and electric components
- Check the tightening of assembling bolts of teeth.
- Check and lubricate the accelerator control, parking brake and speed control systems.
- Other checking and adjusting parts.
- Refers to "Operation and Maintenance Manual" of diesel engine for maintenance.

3.2.3 Every 200 Hours Service

Perform the service operation of every 10 and 50 hours maintenance.

- Check and add battery fluid, clean surfaces and terminals, coat with thin Vaseline.
- Check whether the assembling bolts of frames are loose and the welding seams are cracking.
- Check the whether the axles, engine, transmission and frames are loose.
- Check the tire pressure. Inflation pressure of front tires should be 0.333~0.353MPa, while that of rear tires is 0.275~0.294MPa.
- Clean filters in torque converter-transmission oil lines.
- Other checking and adjusting parts.
- Refers to "Operation and Maintenance Manual" of diesel engine for maintenance.

3.2.4 Every 500Hours Service

Perform the service operation of every 10, 50 and 200 hours maintenance.

- Change oil in transmission, clean oil pan and filter.
- Adjust the parking brake clearance.

- Check whether the brake discs are worn.
- Wash the magnet valve muffler.
- Replace with new return oil filter
- Other checking and adjusting parts.
- Refers to "Operation and Maintenance Manual" of diesel engine for maintenance.

3.2.5 Every 1000 Hours Service

Perform the service operation of every 10, 50, 200 and 500 hours maintenance.

- Change gear oils in front and rear axles.
- Change the oil in hydraulic system, clean hydraulic oil reservoir, filters and breather.
- Jack up the machine and rotate the wheels to check for flexibility.
- Check the pins and bushes at each pivot point for the wearing condition.
- Clean and check the booster, change brake fluid and check for flexibility.
- Other checking and adjusting parts.
- Refers to "Operation and Maintenance Manual" of diesel engine for maintenance.

3.2.6 Every 2000 Hours Service

Perform the service operation of every 10, 50, 200, 500 and 1000 hours maintenance.

- Check the performance of torque converter and transmission, and disassemble for check when necessary.
 - Disassemble the axles, differential and final reducer for check.
 - Check the sealing performance of multi-way valve and hydraulic cylinders by measuring the natural falling volume of cylinders. Check the system pressure. If the falling volume is over rated value, check or replace the multi-way valve or cylinders. Consult the manufacturer of the machine for details.
- Check the welding seams of hubs and other stress parts and adjust the deformation.
- Other checking and adjusting parts.
- Refers to "Operation and Maintenance Manual" of diesel engine for maintenance.

3.2.7 Replace with new air-storage tank after 3-year operation of the machine.

CHAPTER V

STRUCTURE & OPERATON OF KEY COMPONENTS

1 ENGINE

The engine system of the machine consists of engine, air cleaner, exhaust pipe, cooling system and pipe lines instructions. Operation and maintenane should conforms to "engine operation and maintenance manual".

Notice:

1. Check the tightening condition of the mounting bolts of the fan teinely.
2. If there is oil in the coolant, or water in the engine oil pan, check for cracks of the T/Q cooler element besides inspection of the engine.
3. Use the rain or tap water or filtered river water as coolant. Well water has the mineral matters, which might cause scale defective heat exchange and overheating, so it should accept softness treatment before being as used coolant.

2 Transmission system

The Power train consists of hydrostatic torque converter, transmission, oil pipe line of hydrostatic torque converter, driving shafts, front and rear axles and wheels. Refers to Fig. 5-1 for the operation.

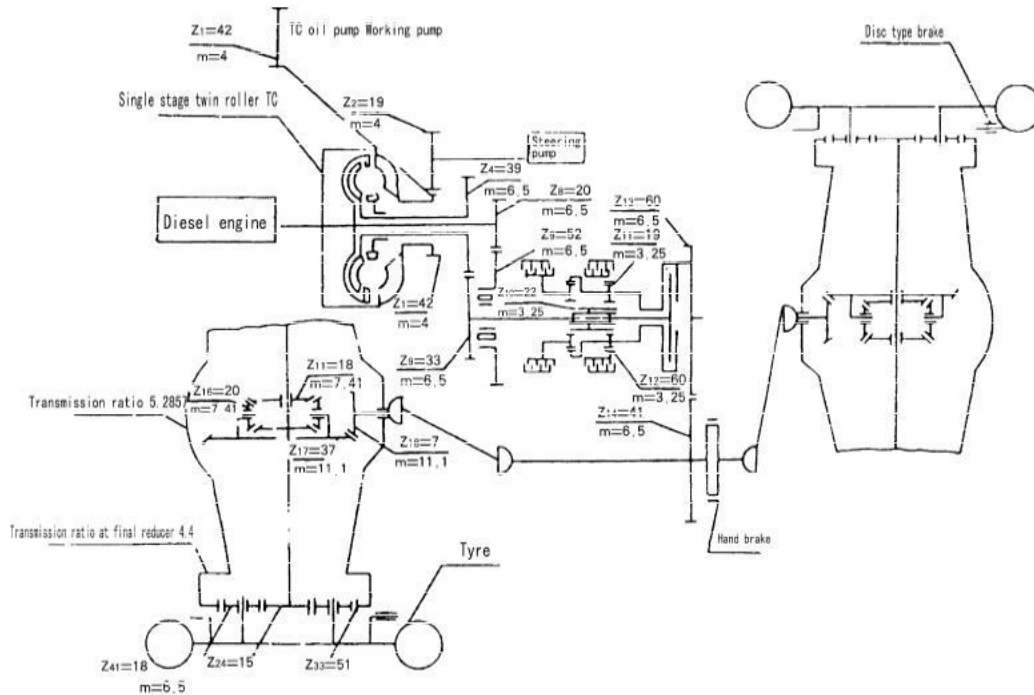

Fig5-1 Power Train

3 WORKING HYDRAULIC SYSTEM

As shown in Fig.5-2, the working hydraulic system consists of working pump, multi-way valve, lift cylinder, dump cylinder, hydraulic oil reservoir and the oil lines. DF32 multi-way valve includes dump section and lift suction. The dump section has 3 positions including dump, hold and tilt, and the lift section has 4 positions including float, lower, hold, and raise to control the operation of the work equipment. The safety valve of the hydraulic system has the set pressure of 18-18.5Mpa. The overload pressure for the bottom end of the dump cylinder is 20.5Mpa, and 12Mpa for the rod end.

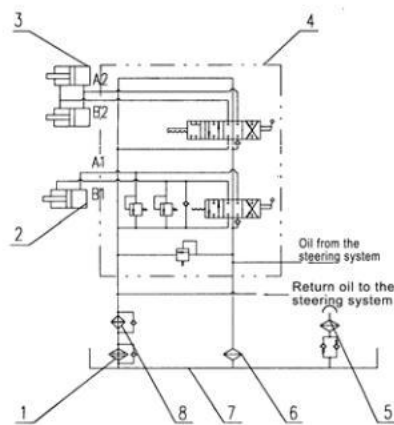

Fig. 5-2 Working Hydraulic System

1. Return oil filter 2. Tilt cylinder 3. Lift cylinder 4. Multi-way valve 5. Air vent cleaner
6. Suction oil filter 7. Hydraulic oil reservoir 8. Radiator

4 BRAKE SYSTEM

The brake system is used to reduce the speed or stop the traveling machine, or used to park the machine on the level ground or slopes for a long time. The operation of the system is shown in Fig.5-3.

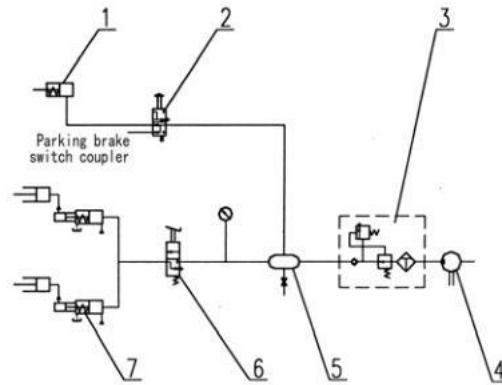

Fig. 5-3 Brake System

1. Parking brake air chamber 2. Brake magnet valve 3. Oil water separator valve
4. Air compressor 5. Air tank 6. Foot brake valve 7. Air booster pump

1. Service brake system

The system is single line, air over oil disc type brake on four wheels.

When the brake pedal is depressed during the machine traveling, the compressed air from the air tank 3 flows into the chamber of air booster 1 through brake valve 2, pushes the booster piston and transfers the pressure to the oil lines (oil pressure is about 14Mpa), which moves the piston of the brake. The friction discs press the brake pad to brake the wheels to reduce the traveling speed or stop the machine.

When the brake pedal is released, the compressed air in the booster is relieved through the brake valve to release the brake.

2. Parking brake system

The system has the spring air chamber to control the disc type brake system. Turn the button of the brake magnet valve slightly during the traveling, and the button will bounce out automatically. The compressed air from the air tank 5 flows into the brake air chamber 1 through magnet brake valve 2, which makes the spring to push the piston and release the brake. When parking, pressed the button and cut off the power to the magnet valve. The compressed air in the chamber flows out through the outlet of the magnet. The spring force pulls up the brake for machine braking. At the same time, electric signals is provided to

make the parking brake pilot light on, and helps operator understand that the machine is in parking condition.

When the air pressure is lower than 0.4Mpa, magnet valve automatically off for emergency brake to protect operator safety.

5 STEERING SYSTEM

The machine adopts fully hydraulic articulated steering system.

The steering system consists of steering pump, load sensing steering unit priority valve, steering cylinder, hydraulic reservoir, oil lines and the attachments, as shown in Fig.5-3. The steering hydraulic system is of independent load sensing type. When the machine turning, the system provides oil to the steering system in priority, and then the remained oil with stering returns oil tank through radiator is to the working system. Safety valve is located on priority valve, with set pressure for the system at 14Mpa.

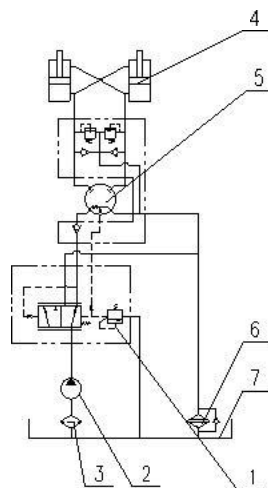

Fig. 5-4 Steering System

- 1.Priority valve 2.Steering pump 3.Suction oil filter 4.Steering cylinder
5.Load sensing fully hydraulic steering unit 6.Return oil filter 7.Hydraulic oil reservoir

6 ELECTRIC SYSTEM

The electric system consists of battery, starting motor, charging alternator, gauges, switches, lamps and other electric parts.

The system voltage is DC 24V, with negative grounding, single line type. Refers to the attached drawing for the relation and operation of electric components.

1. Battery

The machine has two batteries in series, providing 24V output.

During normal operation, the batteries should be charged and discharged frequently. It is unnecessary to remove the battery for charging. If the machine is to be parked for a long time, the batteries should be removed from the machine and be charged once a month.

Never check the battery capacity with the short circuit method, to avoid over large electric current at a sudden moment which will cause severe capacity loss of battery and damage battery of battery. Normal operation is to check battery capacity through magic eye.

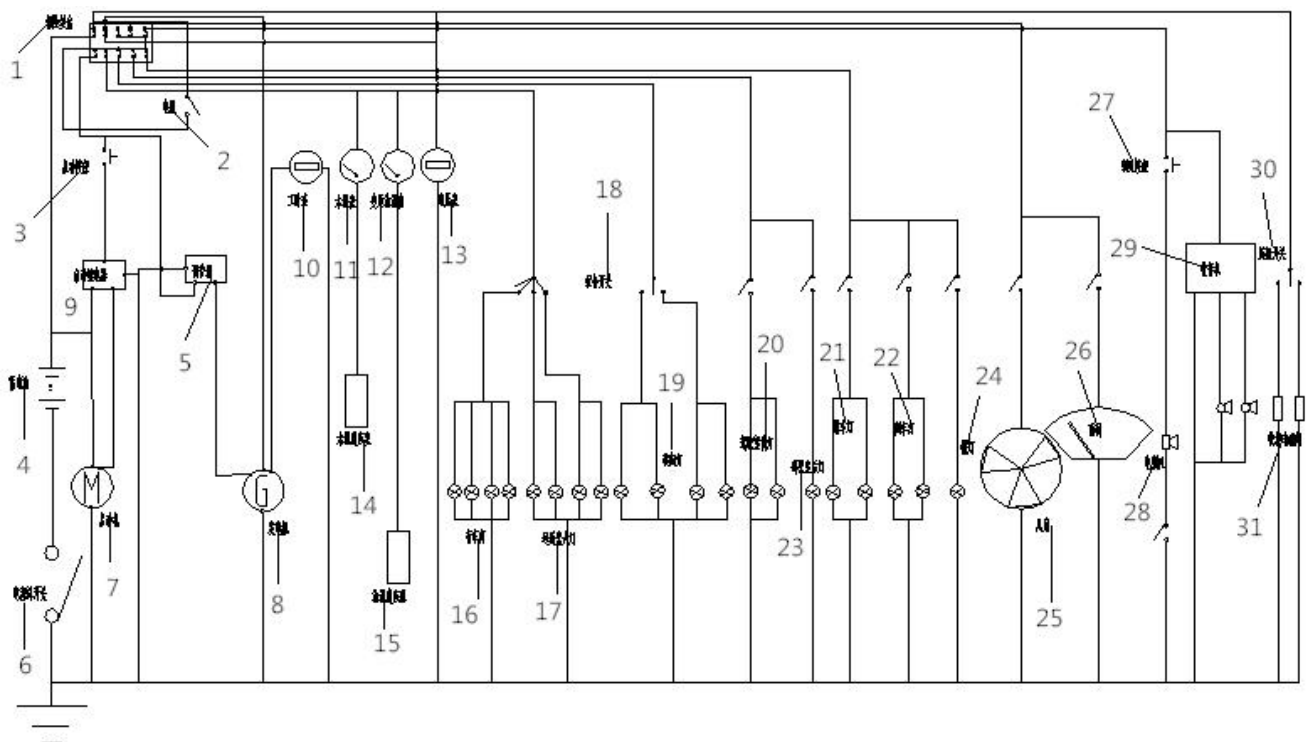

1. Fuse box
2. Electric box
3. Start button
4. Battery
5. Regulator
6. Battery main switch
7. Starting motor
8. Alternator
9. Starting relay
10. working hour meter
11. water-thermometer
12. torque convertor oil temp
13. Voltmeter
14. Water sensor plug
15. Oil temp sensor plug
16. Driving lamp
17. Head lamps
18. Combination switch
19. Turning lights
20. Cab headlight
21. Stop lamp
22. Reserving lights
23. Cab tail light
24. Alarm lamp
25. Fan
26. Wiper blade
27. Horn button
28. Electric horn
29. Radio
30. Rotary switch
31. Q-hitch magnetic valve